

Space

Lightweight and high reliability

Edition 2020



**Lightweight and
high reliability**



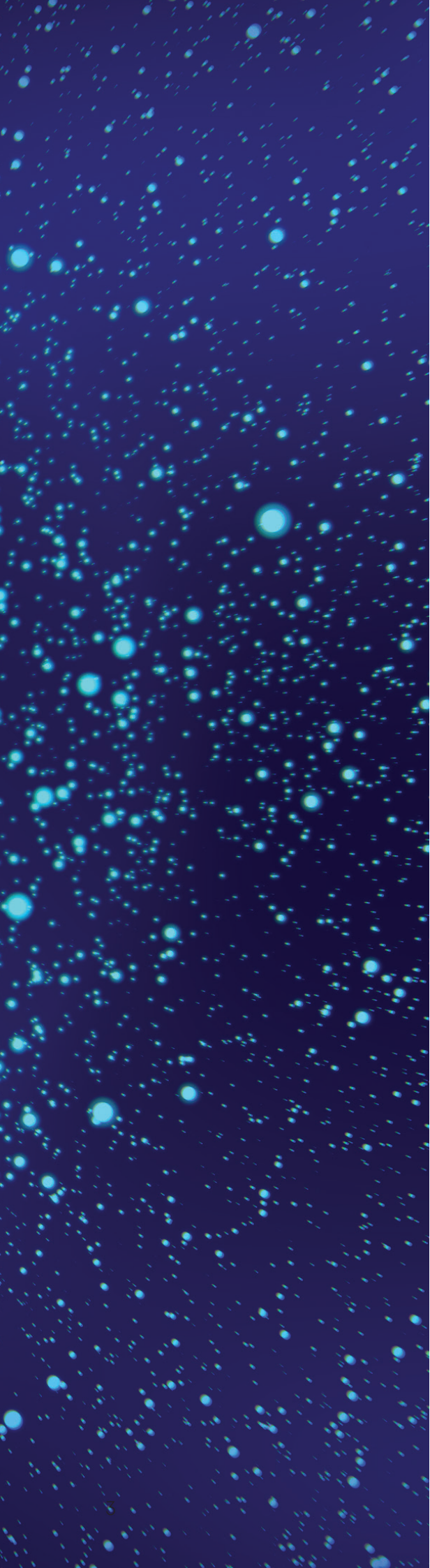

About HUBER+SUHNER

HUBER+SUHNER is a global company with headquarters in Switzerland which develops and manufactures components and system solutions for electrical and optical connectivity.

With cables, connectors and systems – developed from the three core technologies of radio frequency, fiber optics and low frequency – the company serves customers in the communication, transportation and industrial sectors. Our products deliver high performance, quality, reliability and long life – even under harsh environment conditions. Our global production network, combined with group companies and agencies in over 80 countries, puts HUBER+SUHNER close to its customers.

Content

Excellence in connectivity solutions	6
Space flight – RF interconnect solutions	8
Space flight – high density solutions	10
Ground testing – TVAC and high power testing	12
Ground testing – laboratory testing	14
Ground communication	16
Products	
Microwave cable assemblies	18
Minibend series	50
Space flight connectors	68
TVAC cable assemblies	102
32071 – high power cable assemblies	114
Spuma	118
RF-over-Fiber series	124
Solutions business	136
Polatis optical switching solutions	138
HEMP and lightning protection	144

Excellence in Connectivity Solutions

Developing the world of Space

Connectivity solutions in the field of satellite communication need to be developed for the harshest environments. For over 25 years, HUBER+SUHNER has been designing and manufacturing state-of-the-art microwave components offering outstanding electrical and mechanical performance.



Globally networked

HUBER+SUHNER products deliver high performance, quality, reliability and long life – even under the toughest conditions. Our global production network, combined with group companies and agencies in over 60 countries, puts us right around the corner from our customers, wherever they may be.

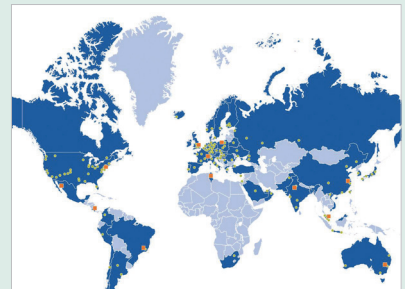

Your partner for system solutions

HUBER+SUHNER is a leading international manufacturer and supplier of components and systems for electrical and optical connectivity. We unite technical and manufacturing expertise in radio frequency, fiber optics and low and high voltage technologies and offer a high quality product range for the space market.



Future proof investment

Rapidly growing demand in the satellite communication requires the integration of innovative high performance solutions. RF components from HUBER+SUHNER take this circumstance into account. Our solutions and components meet our customers current and future requirements for all applications in the Satcom, Spaceflight and Ground testing markets, regardless the technology deployed.



Wide portfolio of in-house capabilities

HUBER+SUHNER possesses the in-house capability to perform thermal cycling, real-time X-ray inspection, and XRF materials analysis as services to our customers. Our manufacturing capabilities incorporate IPC, NASA and ESA workmanship standards, clean room manufacturing and testing (class 100 and 10 000) as well as technical training and certification programmes.



Swiss precision delivered worldwide

HUBER+SUHNER is a Swiss company which prides itself in honesty, fairness and social responsibility. Furthermore, HUBER+SUHNER embodies the values traditionally associated with Swiss engineering excellence – those of quality, precision, reliability and high-performance. Even though the needs of a global market cannot be fulfilled from a single location, those values best associated with Switzerland are embedded globally.



Space flight – RF interconnect solutions

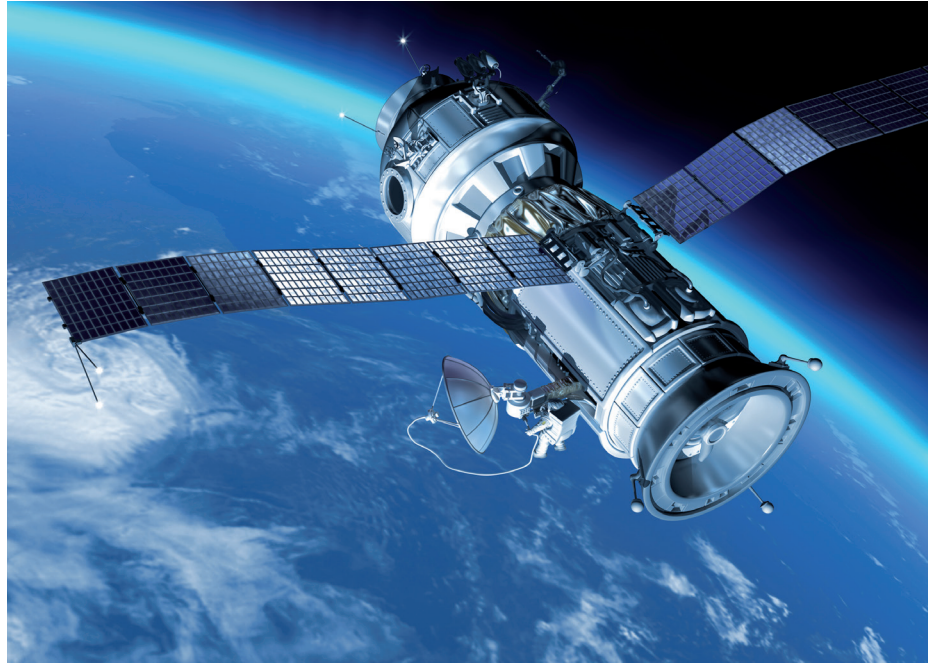

Since the turn of the century, our passive microwave products have been successfully employed in various commercial and scientific research projects in the Space market. HUBER+SUHNER's spaceflight heritage ranges from Low Earth Orbit (LEO), Medium-Earth-Orbit (MEO), Geo-Synchronous Orbit (GSO), and interplanetary applications, spanning both manned and unmanned missions. The HUBER+SUHNER quality system is certified by the Swiss Association for Quality Assurance Certificates (SQS, based on ISO 9001, EN 9100, and ISO 14001) and the National Quality Assurance (NQA, based on AS 9100) and governs all business activities throughout the organization.

Connectivity solutions in the field of satellite communication need to be developed for the harshest environments. For over 25 years, HUBER+SUHNER AG has been designing and manufacturing state-of-the-art microwave components offering outstanding electrical and mechanical performance. Our carefully balanced portfolio of passive components offers proven solutions for satellite communication up to 110 GHz. We offer a full range of component materials and ruggedizations as well as patented, leading-edge connector termination methods that ensure reliable performance of our products in even the most extreme environments.

High performance assemblies

The light-weight, low-loss SUCOFLEX 300 series of microwave cable assemblies offer consistent outstanding mechanical and electrical performance, stability and reliability up to 40 GHz. Offering weight reduction of up to 40 % compared to our conventional products, SUCOFLEX 300 cable assemblies are produced in a clean room environment (class 100).



High radiation resistance

HUBER+SUHNER extends the RF cable assembly portfolio with five-shielded cable assemblies for high radiation space applications. The minibend HBR offers a frequency range up to 65 GHz and industry leading 200 MRad radiation resistance.



High power solutions

The PSM (Power Sub Miniature) interface meets the increasing demand for cost effective, low weight and power sensitive aerospace applications. The PSM connector system enables customers to maximize connector density and minimize overall system weight.



Phase shifters and hermetic adaptors

HUBER+SUHNER offers a wide array of hermetic feed-thru style adaptors and phase shifters that offer both in-series and between-series interface solutions for space flight and TVAC testing applications. The hermeticity is provided by a glass fired seal within the adaptor body. The glass material is selected to provide the best electrical performance while also matching the coefficient of thermal expansion of the surrounding body and contact as closely as possible to prevent any loss of hermeticity. All hermetic adaptors are 100 % tested for hermeticity in accordance with ASTM E-498, MIL-STD-202, and MIL-STD-883.



High power cable assemblies

The 32071 cable assemblies are optimised for extremely high power handling applications. The dielectric core construction provides uncompromising mechanical strength and durability along with a high velocity of propagation. These cable assemblies are ideal solutions for high power space flight and TVAC testing applications.



Space flight – high density solutions

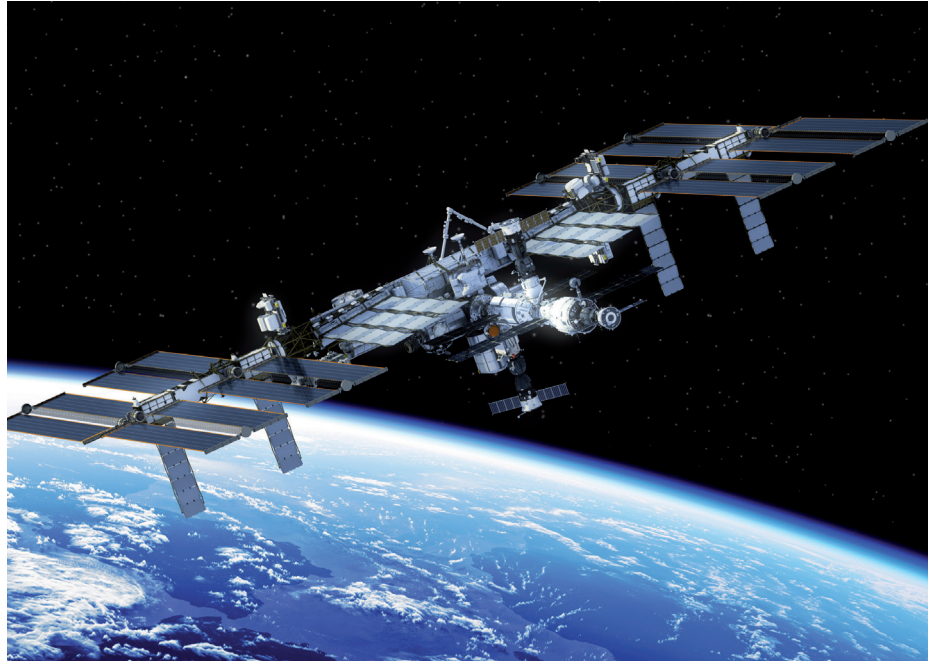

HUBER+SUHNER provides complete project management of customer/industry screening and qualification test plans, test profiles, and report compilation. This includes the utilisation and sourcing of Qualified Testing Suppliers List (QTSL) laboratories and the definition of DPA procedures and testing for custom hybrid components outside of the scope of MIL-STD-1580. Sourcing, traceability and assembly processes are performed according to ESA, NASA and MIL standards. Our extensive manufacturing, quality control, and quality assurance capabilities exist to continuously provide our customers with product of the highest quality and reliability for their demanding space flight applications.

High density RF connectors

High density, multi-coaxial connector solutions combine small size and light weight MIL-standard SMPM interfaces with the reliability of threaded and keyed harnesses.

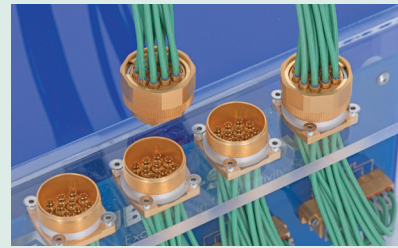

Minibend series

Minibend is a truly flexible, solderless coaxial cable assembly designed for use in low profile, internal, point-to-point interconnections between RF modules within communications systems. Minibend replaces 0.047, 0.086 and 0.141 inch custom semi-rigid cables with standard flexible cables, eliminating the need for predefined custom lengths and bend configurations.



SMPM/SMP

HUBER+SUHNER SMPM/SMP connectors offer reliable instead of unrivaled miniaturization and performance for RF applications up to 65 GHz. SMPM/SMP connectors are MIL-SPEC qualified for defense and space flight applications. Along with the unique bend-to-the-end microbend style cable connectors, HUBER+SUHNER offers a large portfolio of different PCB mount SMPM/SMP connectors that have been designed with optimized PCB trace launch geometries to offer a complete interconnect design solution from "wire-to-trace".



SMPM-T

The SMPM-T is the smallest threaded open source connector on the market. Its unique and innovative combination of a MIL-STD-348 SMPM female interface connector together with a retractable threaded nut provides an integrated solution offering unprecedented electrical and mechanical performance. The SMPM-T handles high density requirements with a connector centerline-to-centerline spacing of just 5 mm (0.20 in) while offering unmatched electrical stability at frequencies up to 65 GHz in even the harshest operating environments.

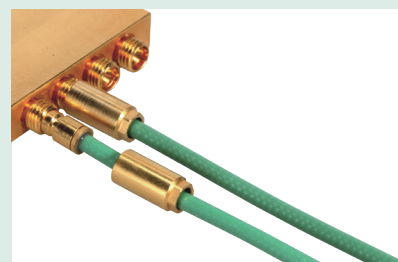

CT product family

The HUBER+SUHNER CT product family is developed for phase critical applications requiring precision electrical length connectivity. Innovative cable manufacturing technology creates a stable and reliable interconnect solution to satisfy a huge range of customer applications where phase stability is key. These products provide industry leading phase vs. temperature performance, as well as a unique range of cable constructions to fulfill any customer demands.



Ground testing – TVAC and high power testing

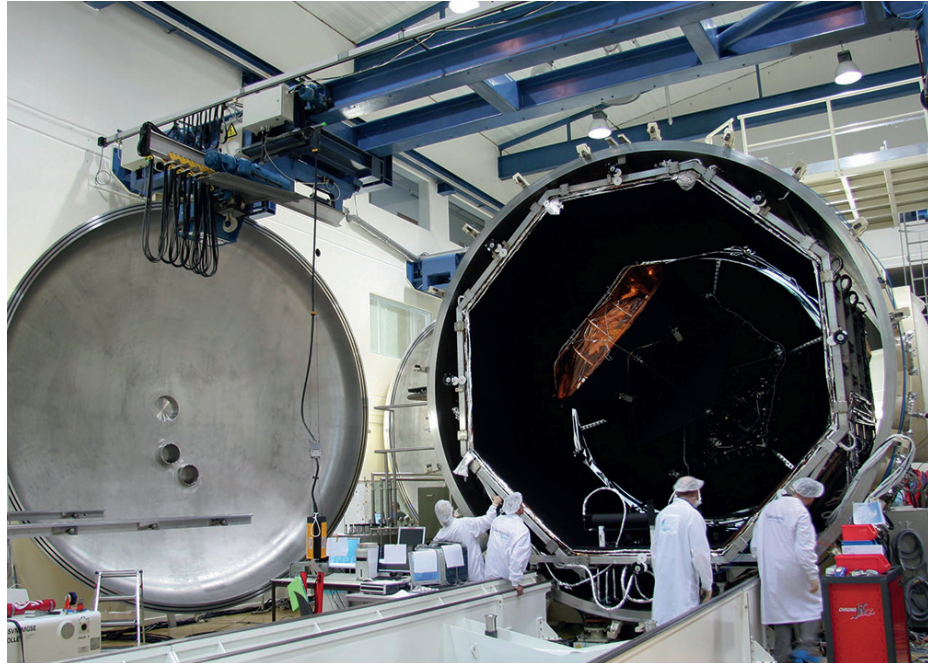

HUBER+SUHNER has emerged as a trusted partner in the Space market for passive microwave components that can be used for satellite testing in clean rooms as well as in a thermal vacuum environment. These components support satellites throughout the entire trial period prior to launch.

Our comprehensive product range is optimally matched to the needs of Space customers and serves as a „one-stop shop“ to simplify the procurement process for low and high power applications. HUBER+SUHNER offers an extensive range of TVAC components, from hermetic adaptors for vacuum chambers, to test cable assemblies for clean rooms, and RF over Fiber connectivity solutions to minimize losses for longer cable runs.

TVAC assemblies

Assemblies used within the vacuum chamber must meet ECSS-Q-ST-70-02 C and NASA reference publication 1124 outgassing standards to prevent contamination of the chamber or equipment by solvents evaporating from certain materials. To prevent internal stresses within the cable assemblies and to ensure an extended service life, HUBER+SUHNER TVAC connectors contain venting holes that allow an unimpeded flow of air into and out of the components during pressurisation/depressurisation cycles.



High power solutions

The 32071 cable from HUBER+SUHNER is optimised for extremely high power handling applications. The dielectric core construction provides uncompromising mechanical strength and durability along with a high velocity of propagation. These cable assemblies are ideal solutions for high power TVAC testing applications.



Microwave cable assemblies

A unique cable and connector design enable SUCOFLEX® 500 test assemblies to deliver best-in-class phase & amplitude stability and outstanding return & insertion loss up to 50 GHz. 70 GHz option coming soon!



Phase shifters and hermetic adaptors

HUBER+SUHNER offers a wide array of hermetic feed-thru style adaptors and phase shifters that offer both in-series and between-series interface solutions for TVAC testing applications. The hermeticity is provided by a glass fired seal within the adaptor body. The glass material is selected to provide the best electrical performance while also matching the coefficient of thermal expansion of the surrounding body and contact as closely as possible to prevent any loss of hermeticity. All hermetic adaptors are 100 % tested for hermeticity in accordance with ASTM E-498, MIL-STD-202, and MIL-STD-883.



RF-over-Fiber

With customers requiring that new solutions and systems combine various technologies, HUBER+SUHNER is able to provide our customers with end-to-end hybrid technology solutions. The RF-over-Fiber series enables the use of radio frequency and fiber optics in a single system. Application support is available for tailored solutions.

RF-over-Fiber GPS-over-Fiber (L1 and L2)
LAN-over-Fiber

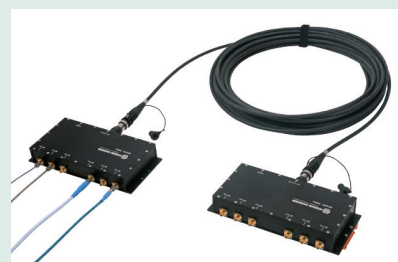

Ground testing – Laboratory testing



Every research and development, test, or quality assurance department that works with RF signals requires precise and repeatable measurements. Since the quality of a test configuration is only as strong as the weakest link, HUBER+SÜHNER offers a wide range of superior flexible and rugged cable assemblies with excellent amplitude and phase stability and high-precision connectors. In addition, we have a full portfolio of adaptors, resistive terminations and attenuators. Reliable cable assembly and resistive solutions guarantee reduced equipment downtime.

SUCOFLEX® 500

When it comes to test and measurement, SUCOFLEX 500 assemblies guarantee the highest level of satisfaction:

- Torque, crush and kink resistant
- Precise and repeatable measurements
- Long service life
- Reduction of total cost of test with durable, reliable performance



SUCOFLEX® 100

The SUCOFLEX 100 series of flexible microwave cable assemblies offer superior electrical and mechanical performance for static and dynamic applications. This series provides optimal performance up to 50 GHz, where stringent electrical requirements – in particular, stability and low loss – are important. The assemblies maintain stable electrical characteristics when exposed to bending and temperature.



Sucotest – the highest standard of measurement

Sucotest is ideal for daily use in component and assembly shops, test labs and high speed digital testing applications up to 40 GHz. Sucotest 18A armoured test assemblies are ideal for testing wireless communication infrastructures and outdoor use.

- Low insertion loss
- Exceptional loss stability
- Excellent return loss



Precision adaptors

HUBER+SUHNER manufactures a wide range of standard and high-performance adaptors that are ideal for lab and production test applications where measurement accuracy, repeatability, and optimum electrical performance are critical.

- Precision interfaces
- Excellent electrical performance
- Premium base materials and platings



Attenuators, terminations and DC blocks

The comprehensive range of high-quality radio frequency attenuators, terminations, and DC blocks is based around the varying needs of test and measurement applications.



Ground communication



The ground segments of satellite communication systems employ a variety of network configurations that provide and manage services delivered to end-users. The broad spectrum of ground station communication typologies are quite similar to installations found in contemporary telecommunications networks in wireless and fixed line services.

With our vast heritage in delivering end-to-end connectivity solutions, HUBER+SUHNER is a value-adding partner in the Ground Communication application landscape. Of particular value is the fact that HUBER+SUHNER is able to deliver all products required in an end-to-end connectivity link out of its own portfolio. Whether it be interconnectivity products, RF-over-Fiber, multiplexers or optical switches, HUBER+SUHNER is leading from the front by offering drop-in ready solutions.

RF-over-Fiber

The RF-over-Fiber series enables the use of radio frequency and fiber optics in a single system. With these two technologies forming a part of HUBER+SUHNER's core technology offering, HUBER+SUHNER has used its vast experience to establish itself as the preferred provider of opto-electronic technology within the space market.

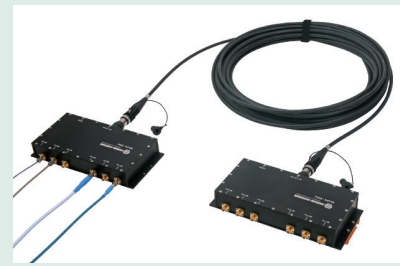

Optical switches

HUBER+SUHNER Polatis is the leading provider of all-optical switches, enabling low latency, fully transparent connections between optical fibers without requiring conversion between optical and electrical signals to offer much greater flexibility and energy efficiency. The patented DirectLight® optical switch technology connects fibers with the best possible optical performance. The modular, strictly non-blocking optical switch platform scales from 4 × 4 to 384 × 384 ports, applying class-leading performance to provide dynamic connectivity for government, data center, test, telecommunications, video network, gateways and teleports.

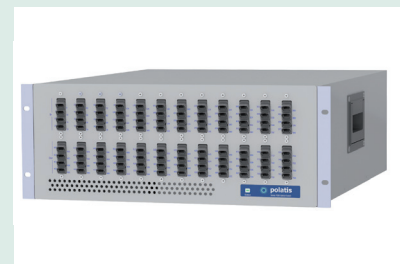

CWDM colour cubes

Coarse Wavelength Division Multiplexing (CWDM) is an excellent choice for increasing bandwidth capacity while keeping costs down. The COLOR cube family, based on standard Thin Film Filter (TFF) technology with a proprietary packaging, offers you smallest component dimensions combined with an outstanding performance and reliability.



Lightning and EMP protection

HUBER+SUHNER offers protection components for terrestrial, airborne and naval tactical communications as well as for navigation, radar and electronic warfare applications and Satcom. HUBER+SUHNER holds groundbreaking patents in the field of coaxial lightning and HEMP protection, such as the automatically suppressing surge arrestor (Semper).



Flexible low loss RF cables

The HUBER+SUHNER Spuma product family stands for lowest loss with halogen free materials. Shielding and VSWR are optimised up to 6 GHz. The cables are more flexible than corrugated ones, allowing easier handling and installation. Tight bending radii are possible. With this set of features, Spuma can support a multitude of applications. Spuma products can also be used as drop-in replacements for LMR® (LMR® is a registered trademark of Times Microwave Inc.).



Microwave cable assemblies

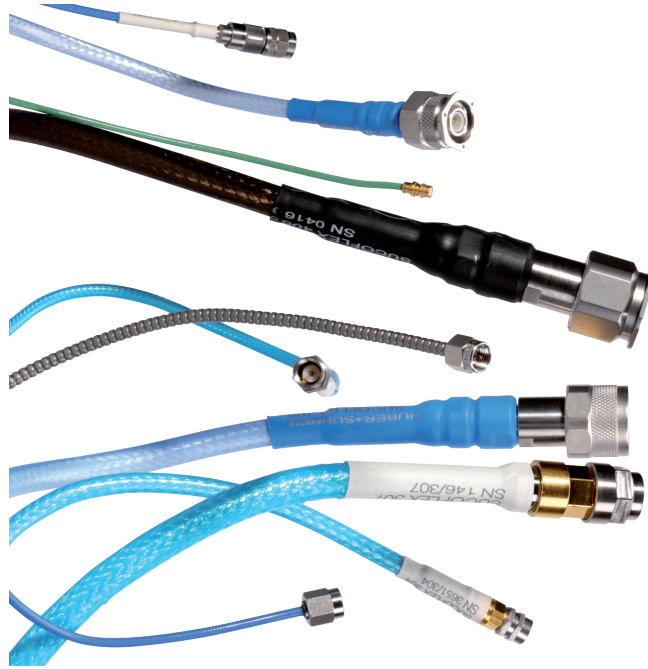

Cables and connectors from the same manufacturer

HUBER+SUHNER develops and manufactures coaxial cables and connectors for a broad array of applications worldwide. Connectors and cables can be optimized for superior electrical performance, offering over 1700 different configurations.

Customers can trust the reliability and quality of HUBER+SUHNER products which are designed and tested per IEC, MIL, CECC among other standards.

Our extensive know-how in RF technology and state of the art manufacturing facilities allow our teams to offer reliable and competent technical consulting and support.

HUBER+SUHNER engineers have vast experience assisting projects optimizing cable connector combinations for the most demanding applications.



Microwave cable assemblies to your specifications

Increase efficiency and productivity in your company by ordering ready-to-use microwave cable assemblies from the specialists. Expert assembly by soldering, clamping or crimping technique and inspection records according to your specifications enabling you to order with confidence, whether built to print or from our portfolio of stock assemblies.

SUCOFLEX 100

The low loss, high performance microwave cable assembly

- For static and dynamic applications up to 50 GHz
- Excellent return loss
- A wide range of connectors is available, including types which feature NWA-specific interfaces, and can be provided with various ruggedizations to protect the assembly against different environmental influences
- Stock assemblies available



SUCOFLEX 200

The loss revolution for dynamic applications

- For static and dynamic applications up to 40 GHz
- Ultra low loss
- Outstanding phase stability vs. temperature
- Excellent return loss

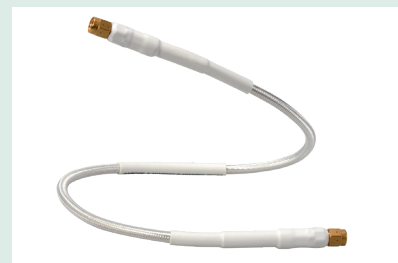

SUCOFLEX 300

The light-weight, low-loss microwave cable assemblies

- SUCOFLEX 300 series offers consistent outstanding mechanical and electrical performance, stability and reliability up to 40 GHz
- Weight reduction of up to 40 % compared to our conventional products
- Assemblies produced in a clean environment room (class 100)



SUCOFLEX 500

When it comes to test and measurement, SUCOFLEX 500 assemblies guarantee the highest level of satisfaction Torque, crush and kink resistant

- Precise and repeatable measurements
- Long service life
- Reduce total cost of test with durable, reliable performance
- Increased test and measurement efficiency saving costs due to reduced calibration intervals



Summary of SUCOFLEX® qualifications

The entire SUCOFLEX family is certified to the following standards through testing, analysis or similarity.

Temperature, altitude and humidity

MIL-STD-810, method 518.1, procedure I

Thermal shock

MIL-STD-202, method 106, condition B1, 25 cycles, temperature: -54 to 125 °C

Mechanical shock

MIL-STD-810, method 516.3, procedure I (half-sine), 20 g, 6 to 9 ms, 45 Hz cross over frequency

MIL-STD-810, method 516, procedure I (saw-tooth), 40 g saw-tooth pulse of 11 ms duration 3 shocks in each of the six directions

Vibration

MIL-STD-810, method 519.3, procedure I, figure 514.3-1, (gunfire), 26.5 min. with specified vibration profile

MIL-STD-810, method 514.3, procedure I (random), functional: 0.2 g²/Hz, endurance: 0.83 g²/Hz

MIL-STD-202; method 204, condition G (sinusoidal), acceleration: 30 g, frequency range: 10 to 2000 Hz, duration: 4 hours in each of three axes

Acceleration

MIL-STD-810, method 513.3, procedure II, 27 g, 5 min.

MIL-STD-810, method 513.3, procedure I, 50 g, 5 min.

Chemical resistance

British standard 3G100, part 2, section 3, class A

Moisture resistance

MIL-STD-202, method 106, 10 day exposure

Salt fog

MIL-STD-810, method 509.2, 48 hours exposure to a 5 % solution

Fungus

MIL-STD-810, method 508.3

Sand and dust

Def. stand. 07-55, part 2, section 4, issue 1, +35 °C, 3 hours

Solar radiation

MIL-STD-810, method 505, procedure II

Overview SUCOFLEX® 100

The high performance microwave cable assembly

Product description

SUCOFLEX 100 series flexible microwave cable assemblies offer superior electrical and mechanical performance for static and dynamic applications.

This series is a high-end product designed to provide optimal performance up to 50 GHz, where stringent electrical requirements – in particular stability and low loss – are important. Their mechanical and climate resistance properties surpass those of standard flexible cables. This cable type is ideally suited to test and measurement applications (as test leads) and used in aerospace and defence systems.



Product features

- The cable maintains stable electrical characteristics when exposed to bending and temperature, enabling reliable test results
- A balanced range of connectors is available, including types which feature NWA-specific interfaces
- Can be provided with various ruggedisations to protect the assembly against different environmental influences
- Available as assembly only

Recommended connectors

SF101 / SF101P	SMA, SK, PC2.4
SF102	SMA, BMA, N, TNC, PC3.5, SK, PC2.4
SF103	BNC, SMA, BMA, N, TNC, PC7, PC3.5
SF126 SF104	BNC, 7/16, SMA, BMA, QMA, TNC, N, QN, PC7, PC3.5
SF106 SF118	7/16, SMA, N, QN, TNC
Other connectors available on request	

Technical data

HUBER+SUHNER cable type	Operating frequency GHz	Temperature range		Outer diameter mm	Nominal atten. 18 GHz, 25 °C dB/m	Bending radii		Weight g/m
		minimum °C	maximum °C			static mm	dyn. mm	
SUCOFLEX_101	50	-55	+125	3.7	2.0	11	20	36
SUCOFLEX_101_P	50	-55	+125	3.7	3.0	11	20	33
SUCOFLEX_101_PE	50	-40	+85	3.7	3.0	11	20	30
SUCOFLEX_102	46	-55	+125	4.0	1.7	12	20	40
SUCOFLEX_102_I	46	-40	+85	4.0	1.7	12	20	36
SUCOFLEX_103	33	-55	+125	4.6	1.3	13	22	53
SUCOFLEX_103_I	33	-40	+85	4.8	1.3	13	20	53
SUCOFLEX_104	26.5	-55	+125	5.5	1.1	16	25	84
SUCOFLEX_104_I	26.5	-40	+85	6.6	1.1	16	25	82
SUCOFLEX_126	26.5	-55	+125	5.5	1.1	16	25	84
SUCOFLEX_126_E	26.5	-40	+85	5.5	1.1	16	25	83
SUCOFLEX_106	18	-55	+125	7.9	0.8	24	40	157
SUCOFLEX_118	18	-55	+125	7.9	0.8	24	40	158
SUCOFLEX_106_I	18	-40	+85	8.2	0.8	24	40	144

SUCOFLEX® 100



SUCOFLEX 100 series flexible microwave cable assemblies offer superior electrical and mechanical performance for static and dynamic applications.

This series is a high-end product designed to provide optimal performance up to 50 GHz, where stringent electrical requirements – in particular stability and low loss – are important. Their mechanical and climate resistance properties surpass those of standard flexible cables. This cable type is ideally suited to test and measurement applications (as test leads) and used in aerospace and defense systems.

Assembly types

		SUCOFLEX 101	SUCOFLEX 102	SUCOFLEX 103	SUCOFLEX 104	SUCOFLEX 126	SUCOFLEX 106	SUCOFLEX 118
Max. operating frequency	GHz	50	46	33	26.5	26.5	18	18
Impedance	Ω	50	50	50	50	50	50	50
Application		static	static	static	static	dynamic	static	dynamic
Velocity of propagation	%	77	77	77	77	77	77	77
Weight	g/m	36	40	53	73	70	145	145
Min. bending radius static	mm	11	12	13	16	16	24	24
Min. bending radius repeated	mm	20	20	22	25	25	40	40
Temperature range	°C	-55 to +125	-55 to +125	-55 to +125	-55 to +125	-55 to +125	-55 to +125	-55 to +125
Crush resistance	kN/m	8	8	8	8	8	12	12
Tensile load	N	100	150	200	250	250	400	400
Inner conductor		solid wire	solid wire	solid wire	solid wire	stranded - low loss	solid wire	stranded - low loss
Dielectric		LD-PTFE	LD-PTFE	LD-PTFE	LD-PTFE	LD-PTFE	LD-PTFE	LD-PTFE
Outer conductor		tape/braid	tape/braid	tape/braid	tape/braid	tape/braid	tape/braid	tape/braid
Jacket		FEP	FEP	FEP	FEP	FEP	FEP	FEP
Ruggedization		on request	on request	on request	on request	on request	on request	on request
Outer diameter	mm	3.7	4.0	4.6	5.5	5.5	7.9	7.9
Screening effectiveness (up to 18 GHz)	dB	> 90	> 90	> 90	> 90	> 90	> 90	> 90
Phase stability vs. flexure (360°, diameter 40 mm)	°el/GHz	< 1.2	< 1.2	< 1.4	< 1.7	< 0.9	< 2.0	< 1.2
Phase stability vs. temperature (-40 to +85 °C)	ppm	< 1500	< 1500	< 1500	< 1500	< 1500	< 1500	< 1500
Assembly phase matching tolerances	°el/GHz	± 0.5	± 0.5	± 0.5	± 0.5	± 0.5	± 0.5	± 0.5
Cable attenuation at 25 °C	dB/m	see graph	see graph	see graph	see graph	see graph	see graph	see graph
Insertion loss stability vs. bending	dB	± 0.2	± 0.2	± 0.2	± 0.2	± 0.2	± 0.2	± 0.2
Insertion loss stability vs. temperature	%/°C	< 0.2	< 0.2	< 0.2	< 0.2	< 0.2	< 0.2	< 0.2
Insertion loss stability vs. shaking	dB	± 0.1	± 0.1	± 0.1	± 0.1	± 0.1	± 0.1	± 0.1
Power handling	Watt	see graph	see graph	see graph	see graph	see graph	see graph	see graph

SUCOFLEX® 100 – graphs

Attenuation (typical values at +25 °C ambient temperature)

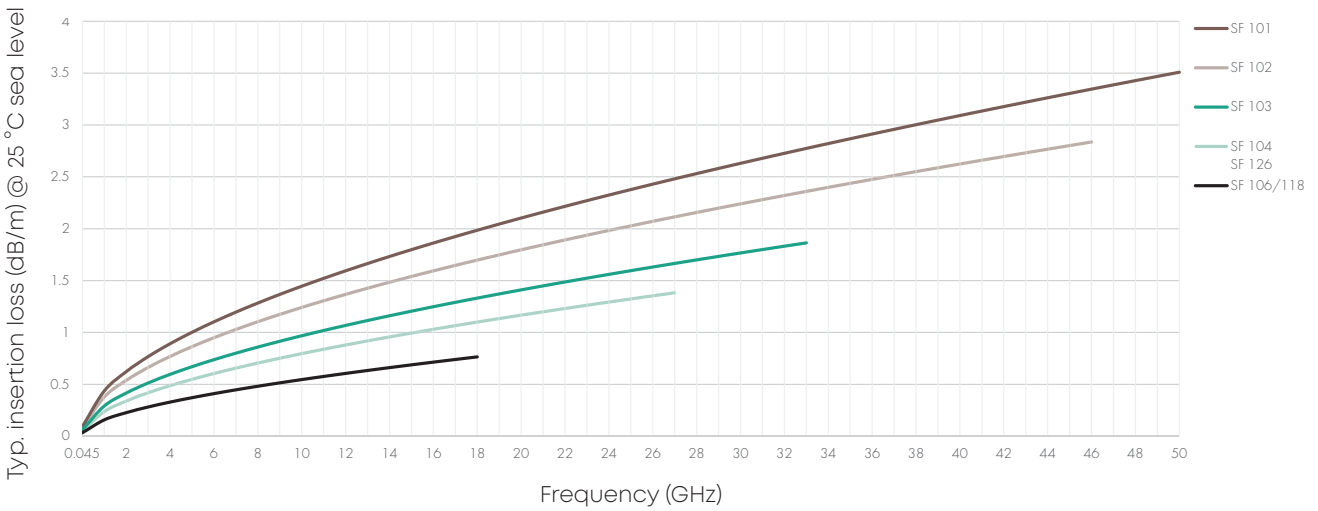

Power handling (maximum values at 25 °C ambient temperature and sea level)

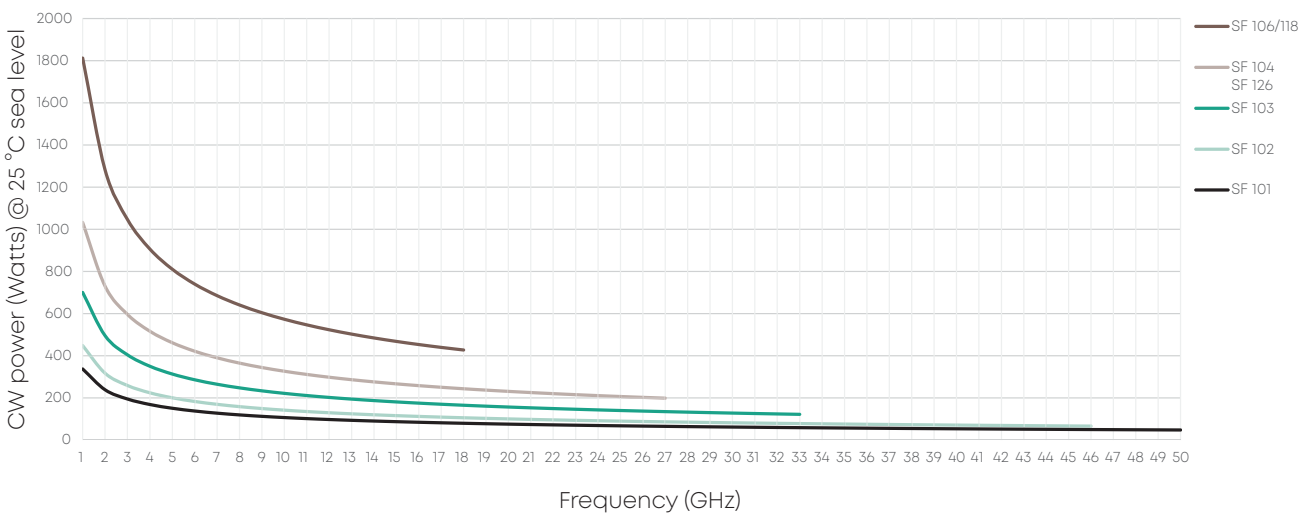

Phase stability versus temperature

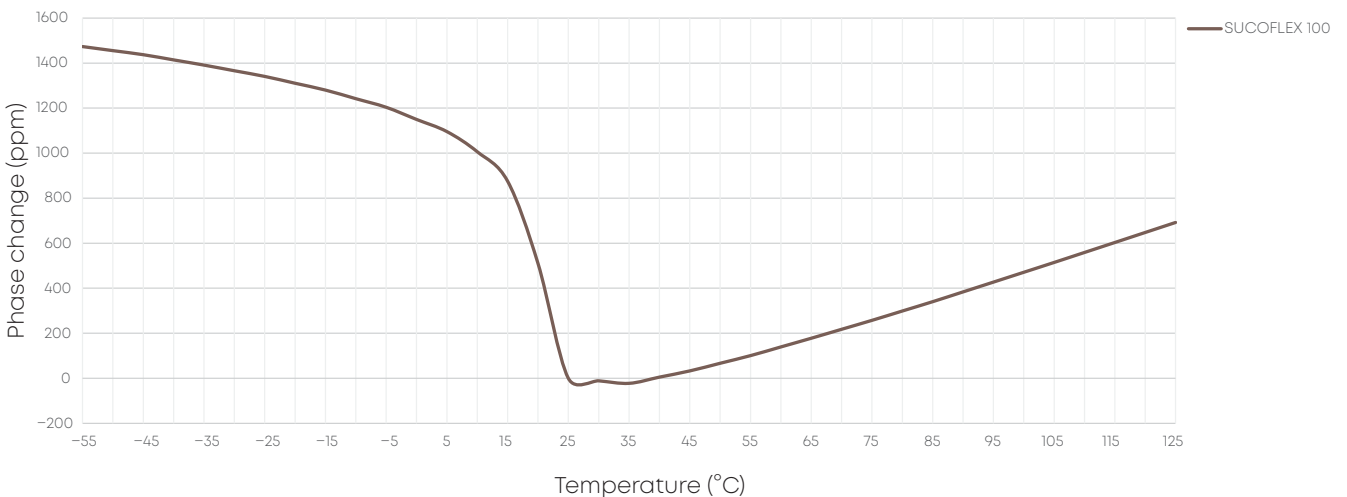

Armoring options

Type A



Consists of a steel spring (round wire), steel braid and polyurethane (TPU) jacket. Up to +85 °C, this ruggedization offers excellent protection against compression, tension, abrasion and other mechanical forces acting upon the cable.

Armoring

Surface	TPU
Max. crush resistance	80 kN/m
Torsional stiffness	$8.5 \times 10 \text{ Nm}^2/\text{°}$

Max. tensile force

Ruggedization	1500 N
Cable connector junction	400 N

Type B



Consists of a flexible hose of stainless steel. The ruggedization protects the cable against compression, abrasion, mechanical injuries, open fire and hot objects (e.g. soldering irons).

The continuous temperature is limited by the cable to +165 °C, and in the immediate proximity of the connectors to the maximum connector temperature.

Armoring

Surface	stainless steel
Max. crush resistance	80 kN/m
Torsional stiffness	$3.2 \times 10 \text{ Nm}^2/\text{°}$

Max. tensile force

Ruggedization	1000 N
Cable connector junction	500 N

Type D

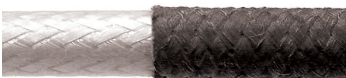

Consists of an aramid yarn braid impregnated with silicon varnish. The ruggedization protects the cable against abrasion and brief high temperatures.

Armoring

Surface	aramid yarn braiding impregnated with silicon varnish
---------	---

Jacket options

Type E

Thermoplastic polyurethane (TPU) jacket for highest flexibility and a low bending moment

Type I

LSFH jacket (low smoke and free of halogen)

Qualifications

Temperature/altitude/humidity

MIL-STD-810C, method 518.1, procedure I

Thermal shock

MIL-STD-202, method 106, condition B1
25 cycles, temperature: -54 to 125 °C

Mechanical shock

MIL-STD-810D, method 516.3, procedure I (half-sine)
20 g, 6 to 9 ms, 45 Hz cross over frequency

MIL-STD-810, method 516, procedure I (saw-tooth)

40 g saw-tooth pulse of 11 ms duration
3 shocks in each of the six directions

Vibration

MIL-STD-810, method 519.3, procedure I, figure 514.3-1
(Gunfire)
26.5 min. with specified vibration profile

MIL-STD-810D, method 514.3, procedure I (random)
Functional: 0.2 g²/Hz
Endurance: 0.83 g²/Hz

MIL-STD-202; method 204, condition G (sinusoidal)
Acceleration: 30 g
Frequency range: 10 to 2000 Hz
Duration: 4 hours in each of three axes

Acceleration

MIL-STD-810D, method 513.3, procedure II
27 g, 5 min.
MIL-STD-810D, method 513.3, procedure I
50 g, 5 min.

Chemical resistance

British standard 3G100, part 2, section 3, class A

Moisture resistance

MIL-STD-202, method 106, 10 day exposure

Salt fog

MIL-STD-810D, method 509.2
48 hours exposure to a 5 % solution

Fungus

MIL-STD-810D, method 508.3

Sand and dust

Def. Stand. 07-55, part 2, section 4, issue 1
+35 °C, 3 hours

Solar radiation

MIL-STD-810, method 505, procedure II

SUCOFLEX® 200



The tape wrapped SUCOFLEX 200 microwave cable assemblies were specifically developed for applications where lowest insertion loss and highest phase stability versus temperature are required.

Assembly types

		SUCOFLEX 229	SUCOFLEX 240
Max. operating frequency	GHz	29	40
Impedance	Ω	50	50
Application		static	static
Velocity of propagation	%	82	82
Weight	g/m	61	31
Min. bending radius static	mm	23	15.2
Min. bending radius repeated	mm	70	25
Temperature range on request	$^{\circ}\text{C}$	-55 to +165 -65 to +200	-55 to +165 -65 to +200
Crush resistance	kN/m	-	-
Tensile load	N	133	133
Inner conductor		solid wire	solid wire
Dielectric		PTFE microporous	PTFE microporous
Outer conductor		flat wire braid	flat wire braid
Barrier		tape/braid	tape/braid
Jacket		FEP	FEP
Ruggedization		on request	on request
Outer diameter	mm	5.1	4.2
Screening effectiveness (up to 18 GHz)	dB	> 90	> 90
Phase stability vs. flexure (360 $^{\circ}$, diameter 55 mm)	$^{\circ}\text{el}/\text{GHz}$	< 0.65	< 0.65
Phase stability vs. temperature (-40 to +85 $^{\circ}\text{C}$)	ppm	< 600	< 600
Assembly phase matching tolerances	$^{\circ}\text{el}/\text{GHz}$	± 0.5	± 0.5
Cable attenuation at 25 $^{\circ}\text{C}$	dB/m	see graph	see graph
Insertion loss stability vs. bending	dB	± 0.2	± 0.2
Insertion loss stability vs. temperature	$\%/^{\circ}\text{C}$	< 0.21	< 0.21
Insertion loss stability vs. shaking	dB	± 0.1	± 0.1
Power handling	Watt	see graph	see graph

SUCOFLEX[®] 200 – graphs

Attenuation (typical values at +25 °C ambient temperature)

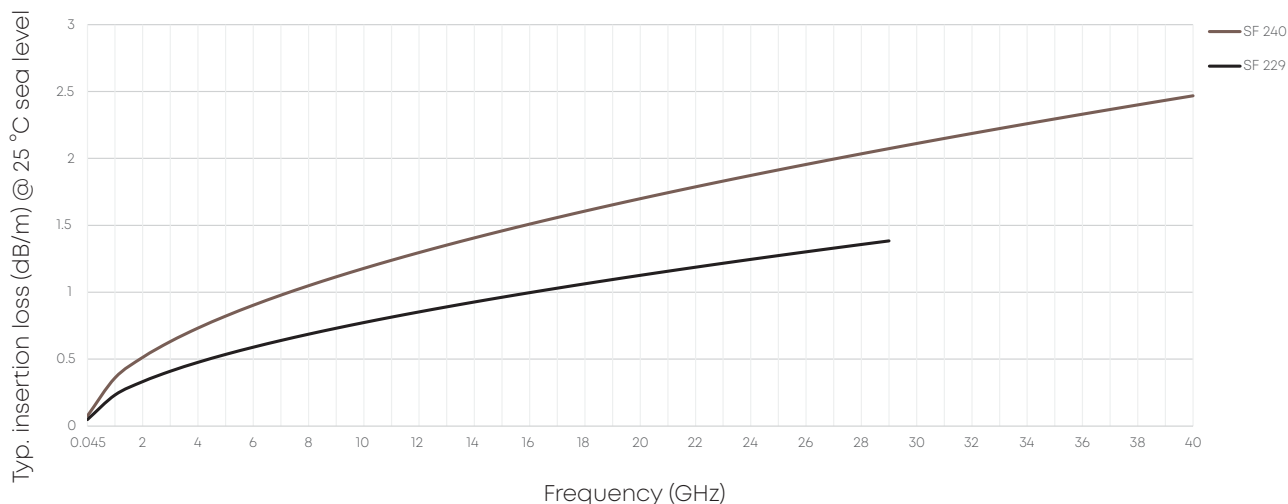

Power handling (maximum values at 25 °C ambient temperature and sea level)

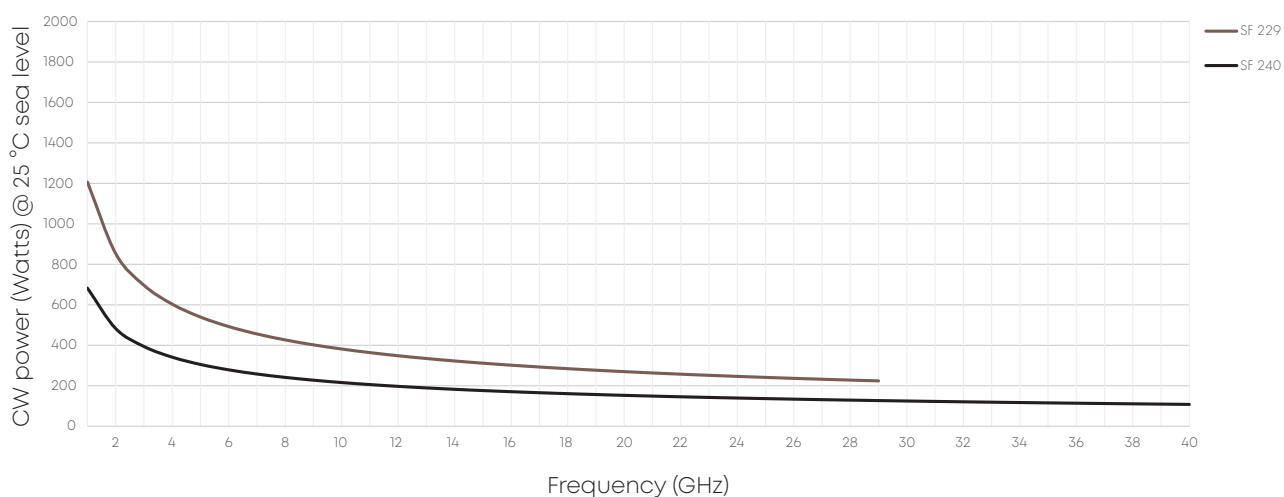

Phase stability versus temperature

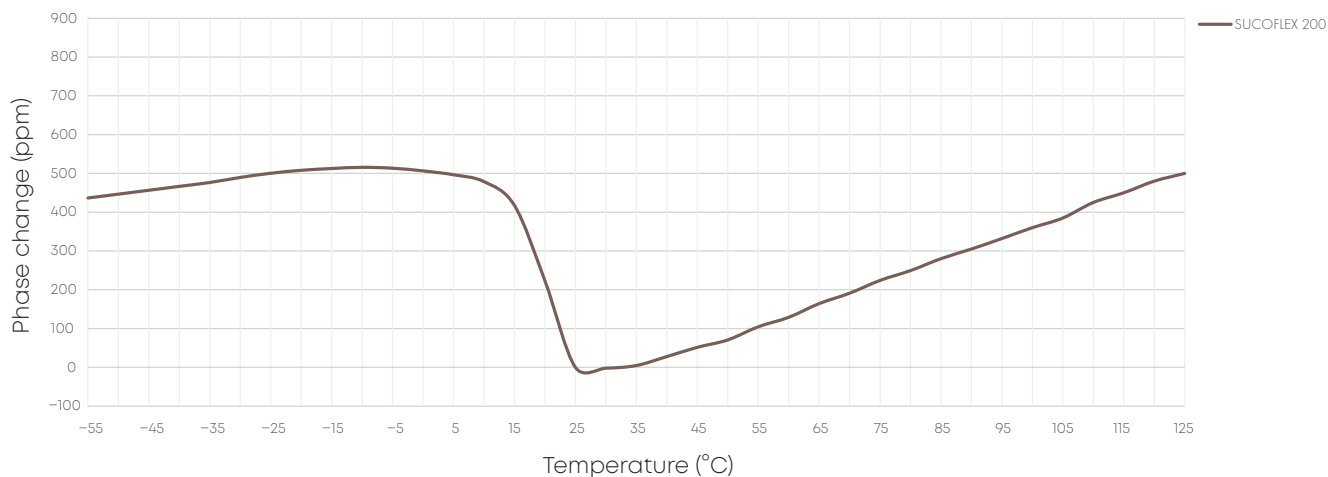

SUCOFLEX® 300



The SUCOFLEX 300 light-weight, low-loss flexible microwave cable assemblies are high-end products designed to meet the stringent needs of space flight systems (e. g. satellites) and aerospace systems (aircraft, UAVs, helicopter, missiles), which are subjected to extremely severe operating conditions.

Assembly types

		SUCOFLEX 304_Space	SUCOFLEX 307_Space	SUCOFLEX 329	SUCOFLEX 340
Max. operating frequency	GHz	18	8	29	40
Impedance	Ω	50	50	50	50
Application		static	static	static	static
Velocity of propagation	%	77	77	82	82
Weight	g/m	46	133	40	27
Min. bending radius static	mm	20	50	23	15.2
Min. bending radius repeated	mm	50	100	70	25
Temperature range	$^{\circ}\text{C}$	-55 to +125	-55 to +150	-65 to +150	-65 to +150
Tensile load	N	250	340	133	133
Inner conductor		solid wire	solid wire	solid wire	solid wire
Dielectric		PTFE microporous	PTFE microporous	PTFE microporous	PTFE microporous
Outer conductor		tape/braid	tape/braid	flat wire braid	flat wire braid
Jacket		ETFE	ETFE	ECTFE	ECTFE
Ruggedization		on request	on request	on request	on request
Outer diameter	mm	5.4	9.0	5.1	4.2
Screening effectiveness (up to 18 GHz)	dB	> 90	> 90	> 90	> 90
Phase stability vs. flexure (360°, diameter 40 mm)	$^{\circ}\text{el}/\text{GHz}$	< 1.5	< 2.0	< 0.65	< 0.65
Phase stability vs. temperature (-40 to +85 $^{\circ}\text{C}$)	ppm	< 1500	< 1500	< 1000	< 1000
Assembly phase matching tolerances	$^{\circ}\text{el}/\text{GHz}$	± 0.5	± 0.5	± 0.5	± 0.5
Cable attenuation at 25 $^{\circ}\text{C}$	dB/m	see graph	see graph	see graph	see graph
Insertion loss stability vs. bending	dB	± 0.1	± 0.1	± 0.2	± 0.2
Insertion loss stability vs. tem- perature	$\%/^{\circ}\text{C}$	< 0.2	< 0.45	< 0.2	< 0.2
Insertion loss stability vs. shaking	dB	± 0.1	± 0.1	± 0.1	± 0.1
Power handling	Watt	see graph	see graph	see graph	see graph
Radiation-gamma	Mrad	100	100	200	200

SUCOFLEX® 300 – graphs

Attenuation (typical values at +25 °C ambient temperature)

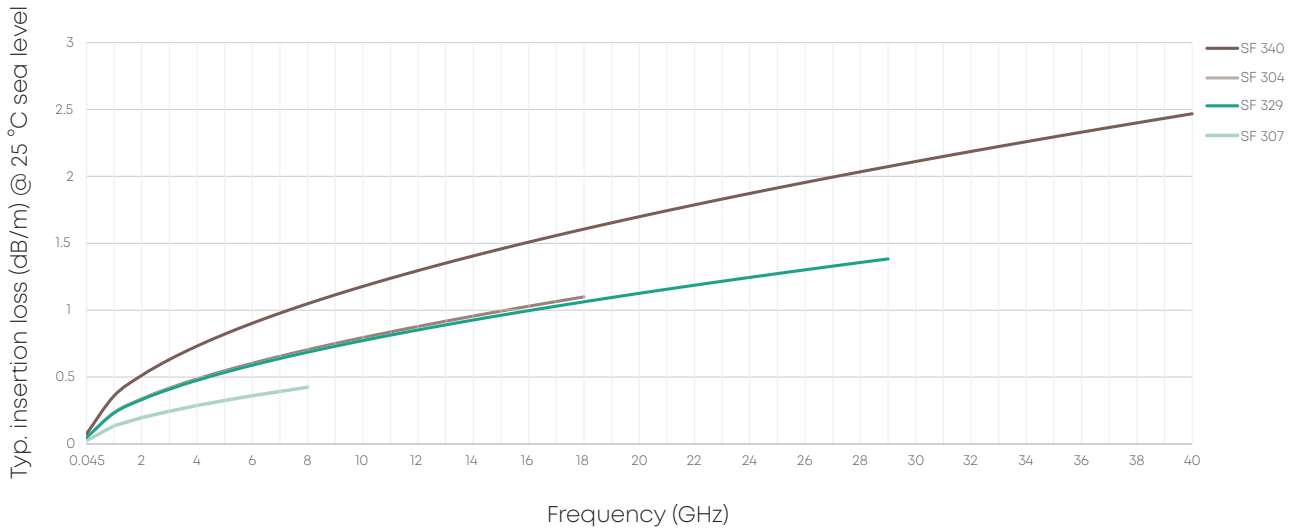

Power handling (maximum values at 25 °C ambient temperature and sea level)

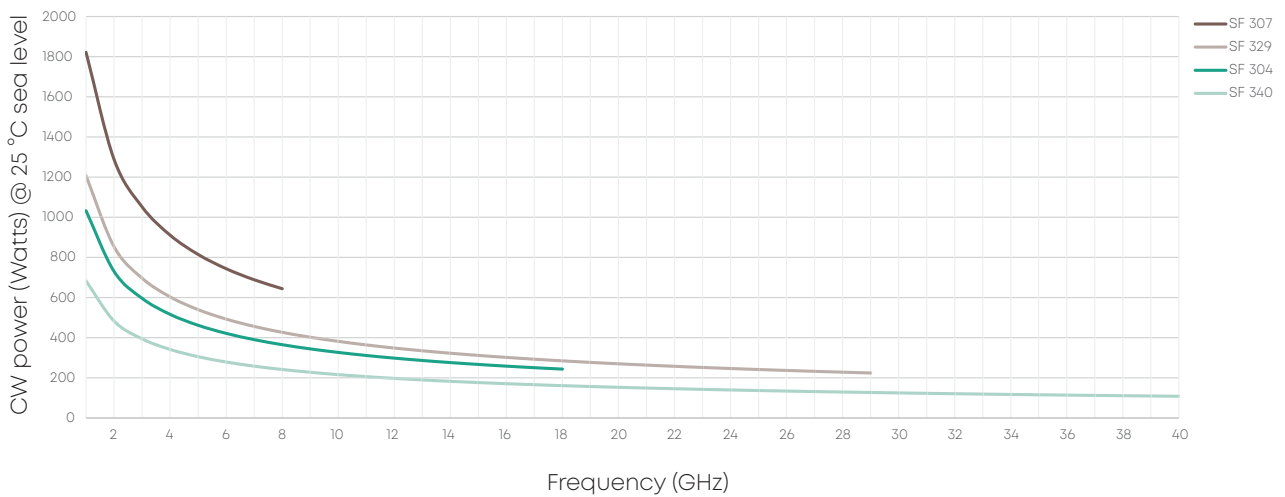

Phase stability versus temperature

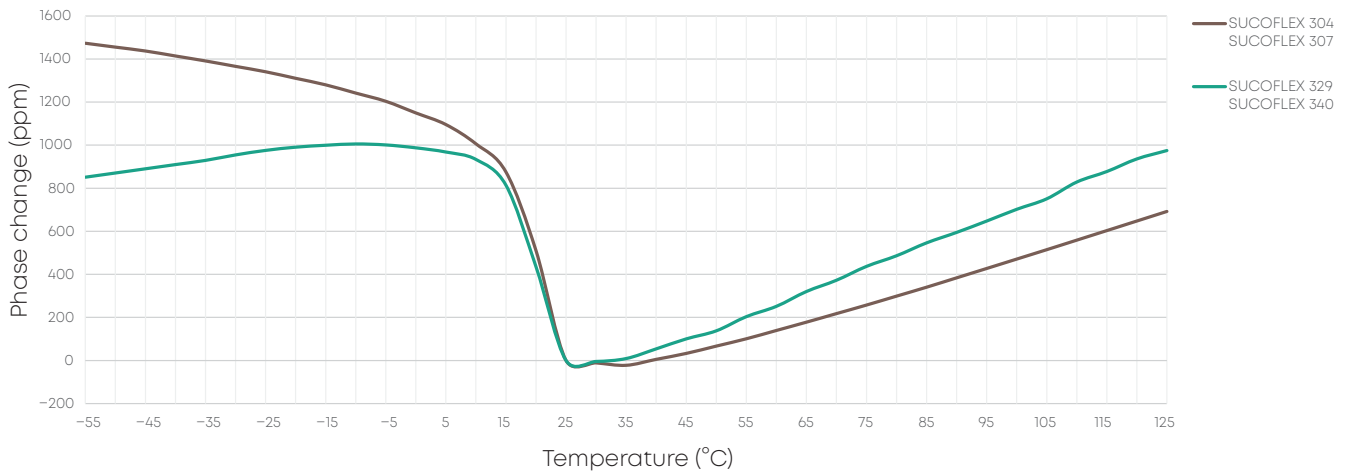

SUCOFLEX® assemblies – insertion loss comparison

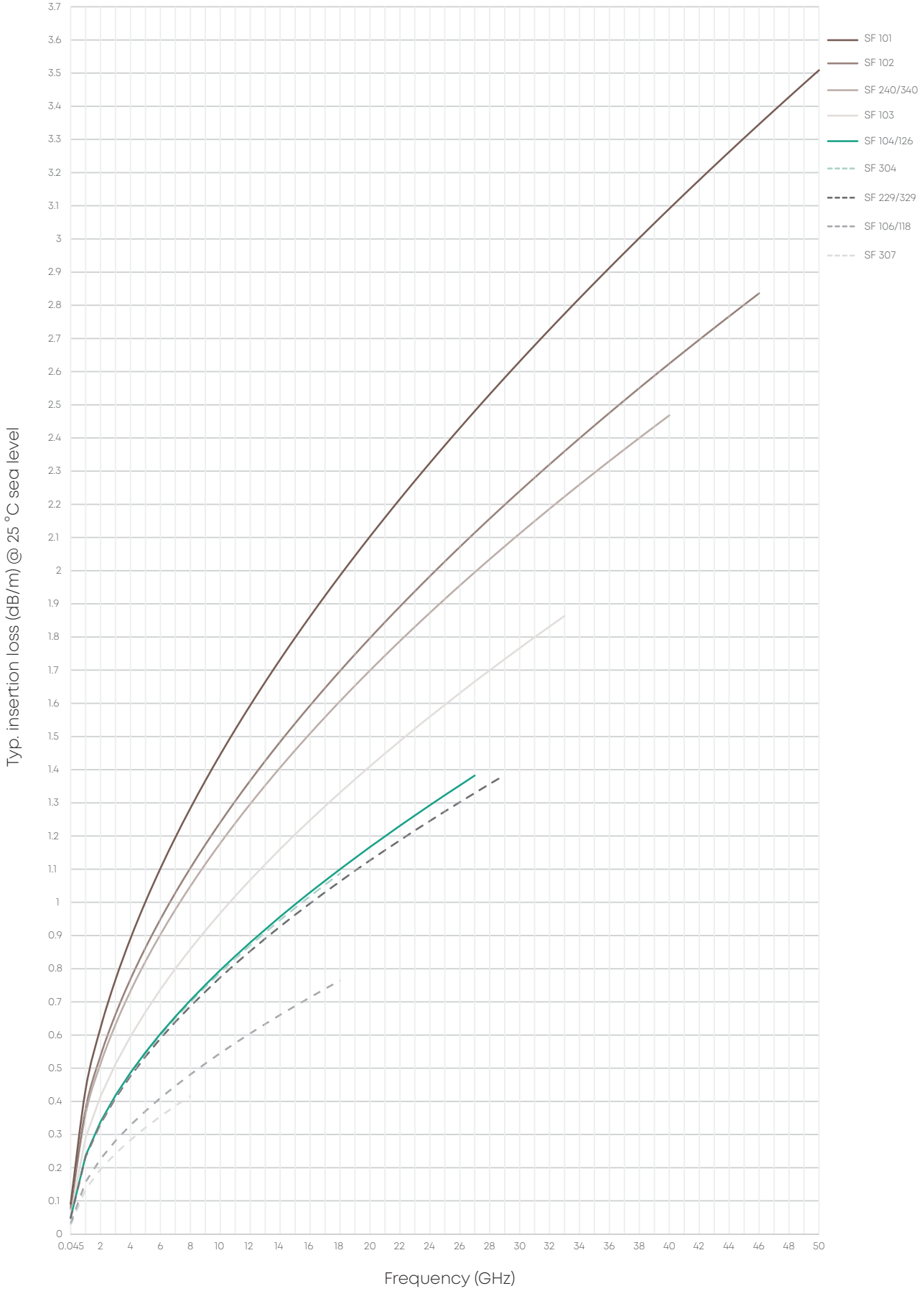

Overview SUCOFLEX® connectors

Cross reference within product range

Outer diameter mm	Cable attenuation at 18 GHz dB/m	Armoring options	Interfaces		BNC	QMA	QN	7/16	BMA	PSM	TNC	N	PC7	SMA	PC3.5	SK	PC2.4	Self- lock
			Cables															
3.7	2.0	A	SUCOFLEX 101											26.5		40	50	
3.7	3.0	A	SUCOFLEX 101 P											26.5		40	50	
4.0	1.7	A, D	SUCOFLEX 102					18			18	18		26.5	26.5	40	46	
4.0	1.7		SUCOFLEX 102 I					18			18	18		26.5	26.5	40	46	
4.1	1.6		SUCOFLEX 240											26.5		40		50
4.2	1.6		SUCOFLEX 340											26.5		40		50
4.6	1.3	A, D	SUCOFLEX 103	4				18			18	18	18	18	26.5			
4.6	1.3		SUCOFLEX 103 I	4				18			18	18	18	18	26.5			
5.1	1.1	A	SUCOFLEX 229								18	18		26.5		29		18
5.1	1.1		SUCOFLEX 329						18		18	18		26.5		29		18
5.4	1.1	D	SUCOFLEX 304								18			18				
5.5	1.1	A, D	SUCOFLEX 104	4	6	6	7.5	18			18	18	18	18	26.5			
5.5	1.1		SUCOFLEX 104 I	4	6	6	7.5	18			18	18	18	18	26.5			
5.5	1.1	A	SUCOFLEX 126	4			7.5	18			18	18	18	18	26.5			
7.9	0.8	A, D	SUCOFLEX 106			6	7.5				18	18		18				
7.9	0.8	A, D	SUCOFLEX 118								18	18		18				
8.2	0.8		SUCOFLEX 106 I			6	7.5				18	18		18				
8.2	0.8		SUCOFLEX 118 I								18	18		18				
9.0	-		SUCOFLEX 307								5.5							

All cable assemblies are qualified according to MIL and are available with phase match and/or armoring.

P: Stranded inner conductor for high flexible cable with improved phase variation vs. flexure

I: LSFH jacket (low smoke and free of halogen)

Stock assemblies

SUCOFLEX® 100

Item no.	Type	Length		Frequency	Max. insertion loss at 25 °C	Max. VSWR	RoHS compliant
		mm	inch	GHz			
SUCOFLEX_101							
85026753	SF101/PC24m/PC24m/500 mm	500	20	50	2.29	1.44	yes
SUCOFLEX_101_EA (armoured)							
85026754	SF101EA/PC24m/PC24m/500 mm	500	20	50	2.29	1.44	yes
SUCOFLEX_102							
84017146	SF102/SKm/SKm/500 mm	500	20	40	1.76	1.44	yes
84017149	SF102/SKm/SKm/1000 mm	1000	40	40	3.21	1.44	yes
SUCOFLEX_102_EA (armoured)							
85026755	SF102EA/SKm/SKm/500 mm	500	20	40	1.76	1.44	yes
85026756	SF102EA/SKm/SKm/1000 mm	1000	40	40	3.21	1.44	yes
SUCOFLEX_104							
84017153	SF104/Nm/Nm/500 mm	500	20	18	0.82	1.35	yes
84016754	SF104/SMAm/SMAm/500 mm	500	20	18	0.82	1.25	yes
84017154	SF104/PC35m/PC35m/500 mm	500	20	26.5	1.01	1.35	yes
84017155	SF104/SMAm/Nm/1000 mm	1000	40	18	1.43	1.30	yes
84017157	SF104/Nm/Nm/1000 mm	1000	40	18	1.43	1.35	yes
84016755	SF104/SMAm/SMAm/1000 mm	1000	40	18	1.43	1.25	yes
84017158	SF104/PC35m/PC35m/1000 mm	1000	40	26.5	1.77	1.35	yes
84017067	SF104/Nm/Nm/1500 mm	1500	59	18	2.03	1.35	yes
84016756	SF104/SMAm/SMAm/1500 mm	1500	59	18	2.03	1.25	yes
84017159	SF104/SMAm/Nm/2000 mm	2000	79	18	2.64	1.35	yes
84017160	SF104/Nm/Nm/2000 mm	2000	79	18	2.64	1.35	yes
84016757	SF104/SMAm/SMAm/2000 mm	2000	79	18	2.64	1.25	yes
SUCOFLEX_126_E							
85072824	SF126E/SMAm/SMAm/500 mm	500	20	18	0.82	1.25	yes
85072825	SF126E/SMAm/SMAm/1000 mm	1000	40	18	1.43	1.25	yes
85072826	SF126E/PC35m/PC35m/1000 mm	1000	40	26.5	1.77	1.35	yes
SUCOFLEX_126_EA (armoured)							
85072828	SF126EA/Nm/Nm/1000 mm	1000	40	18	1.43	1.25	yes
85072827	SF126EA/SMAm/SMAm/1000 mm	1000	40	18	1.43	1.25	yes
85072829	SF126EA/Nm/Nf/1500 mm	1500	59	18	2.03	1.25	yes
85072830	SF126EA/Nm/Nm/1500 mm	1500	59	18	2.03	1.25	yes

SUCOFLEX® 500



Short delivery time



Outstanding performance



Excellent price-performance ratio

When it comes to test and measurement, the SUCOFLEX 500 assemblies guarantee the highest level of satisfaction. Thanks to their unique cable and connector design, they deliver the best phase and amplitude stability versus flexure, movement, temperature and tensile stress, in combination with outstanding return and insertion loss up to 50 GHz.

Due to the rotary swaged low-loss inner conductor and the rugged construction, all SUCOFLEX 500S assemblies withstand more than 100,000 flexures without degradation of performance and therefore have a very long life-time.

HUBER+SUHNER supplies all SUCOFLEX 500 standard length products within five working days and customised lengths are available within ten working days worldwide.

SUCOFLEX 550S

40-50 GHz

- Very long life time (> 100 000 flex cycles)
- Excellent insertion loss
- Phase and amplitude stability with flexure and movement



SUCOFLEX 526S

26.5 GHz

- Very long life time (> 100 000 flex cycles)
- Excellent insertion loss
- Phase and amplitude stability with flexure and movement



SUCOFLEX 526V

26.5 GHz

- Extremely flexible and ease of handling
- High stable electrical performance
- Best-in-class phase and amplitude stability with flexure, movement, temperature and tensile stress



Applications

- Bench top testing
- RF production testing
- Automated test equipment
- Vector network analyzers (VNAs)
- Scalar analyzers
- Portable test equipment
- RF module testing
- High speed digital testing (HSDT)

„Historically, solutions come in standard lengths that are expensive with a long delivery wait, so we are thrilled to be able to offer high performance microwave cable assemblies that are customisable, affordable and quick.“

Daniel Ulmer,
Product Manager

SUCOFLEX 550S

Unique cable construction

Stranded low loss inner conductor

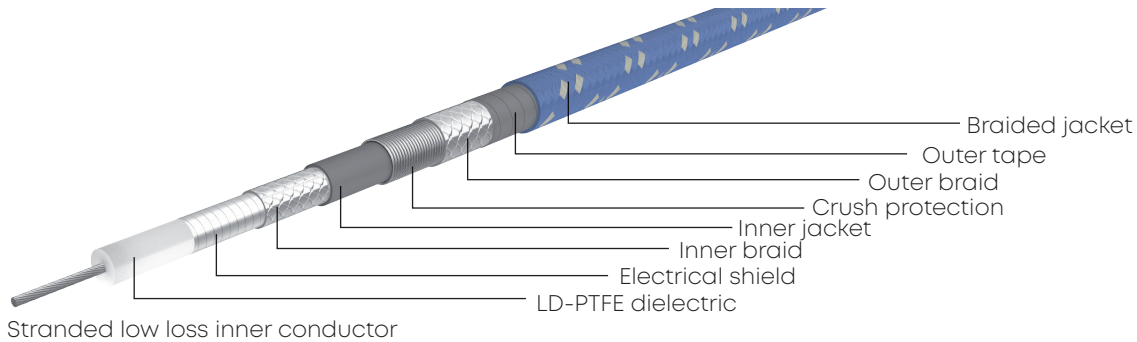

Mechanical data

Frequency	26.5 GHz	40 GHz	50 GHz
Cable	SUCOFLEX 526S	SUCOFLEX 550S	SUCOFLEX 550S
Connector	PC3.5	SK / 2.92 mm	PC2.4
Diameter (mm)	7.7		6.1
Min. bending radius (mm)	25.4		
Typ. flex life (cycles)	> 100'000		
Min. assembly length	300		
Max. assembly length	50'000	20'000	

Environmental data

Operating temperature (°C)	-55 to +125
2011/65/EC (RoHS)	compliant

Electrical data

Impedance (Ω)	50		
Velocity of propagation (%)	77		
Time delay (ns/m)	4.32		
Typ. return loss (dB)	25	19	17
Min. return loss (dB)	19	15	15
Typ. insertion loss assembly (dB/m)	1.63	3.41	3.87
Max. insertion loss assembly (dB/m)	1.77	3.72	4.22
Min. screening effectiveness (dB) up to 18 GHz	90		
Typ. amplitude stability vs. movement (dB)	±0.05		
Typ. amplitude stability vs. flexure (dB)	±0.05		
Typ. phase stability vs. flexure (°)	±3	±5	±6

SUCOFLEX 550S – Stock assemblies

Delivery time within five working days worldwide

Art. No	Cable	Connector 1	Connector 2	Gender	Length (mm)	Length (inch)	Frequency (GHz)	max. IL (dB)	min. RL (dB)
85120065	SUCOFLEX 550S	11 PC24	11 PC24	male/male	610	24	50	2.89	14.9
85120066	SUCOFLEX 550S	11 PC24	11 PC24	male/male	914	36	50	4.07	14.9
85118941	SUCOFLEX 550S	11 PC24	11 PC24	male/male	1000		50	4.22	14.9
85120068	SUCOFLEX 550S	11 PC24	11 PC24	male/male	1219	48	50	5.24	14.9
85118942	SUCOFLEX 550S	11 PC24	11 PC24	male/male	1500		50	6.33	14.9
85120069	SUCOFLEX 550S	11 PC24	21 PC24	male/female	610	24	50	2.89	14.9
85120070	SUCOFLEX 550S	11 PC24	21 PC24	male/female	914	36	50	4.07	14.9
85118943	SUCOFLEX 550S	11 PC24	21 PC24	male/female	1000		50	4.22	14.9
85120072	SUCOFLEX 550S	11 PC24	21 PC24	male/female	1219	48	50	5.24	14.9
85124229	SUCOFLEX 550S	11 PC24	21 PC24	male/female	1500		50	6.33	14.9
85120073	SUCOFLEX 550S	11 SK	11 SK	male/male	610	24	40	2.58	14.9
85120074	SUCOFLEX 550S	11 SK	11 SK	male/male	914	36	40	3.61	14.9
85118944	SUCOFLEX 550S	11 SK	11 SK	male/male	1000		40	3.72	14.9
85120075	SUCOFLEX 550S	11 SK	11 SK	male/male	1219	48	40	4.65	14.9
85123652	SUCOFLEX 550S	11 SK	11 SK	male/male	1500		40	5.57	14.9
85123656	SUCOFLEX 550S	11 SK	21 SK	male/female	610	24	40	2.58	14.9
85123657	SUCOFLEX 550S	11 SK	21 SK	male/female	914	36	40	3.61	14.9
85118945	SUCOFLEX 550S	11 SK	21 SK	male/female	1000		40	3.72	14.9
85123658	SUCOFLEX 550S	11 SK	21 SK	male/female	1219	48	40	4.65	14.9
85123655	SUCOFLEX 550S	11 SK	21 SK	male/female	1500		40	5.57	14.9

SUCOFLEX 526S – Stock assemblies

Art. No	Cable	Connector 1	Connector 2	Gender	Length (mm)	Length (inch)	Frequency (GHz)	max. IL (dB)	min. RL (dB)
85090623	SUCOFLEX 526S	11 PC35	11 PC35	male/male	500	20	26.5	1.01	19.0
85088164	SUCOFLEX 526S	11 PC35	11 PC35	male/male	914	36	26.5	1.64	19.0
85090624	SUCOFLEX 526S	11 PC35	11 PC35	male/male	1000	39	26.5	1.77	19.0
85092087	SUCOFLEX 526S	11 PC35	11 PC35	male/male	1500	59	26.5	2.52	19.0
85090625	SUCOFLEX 526S	11 PC35	11 PC35	male/male	2000	79	26.5	3.27	19.0
85090626	SUCOFLEX 526S	11 PC35	11 PC35	male/male	3000	79	26.5	4.77	19.0
85093097	SUCOFLEX 526S	11 PC35	21 PC35	male/female	500	20	26.5	1.01	19.0
85090629	SUCOFLEX 526S	11 PC35	21 PC35	male/female	914	36	26.5	1.64	19.0
85093184	SUCOFLEX 526S	11 PC35	21 PC35	male/female	1000	39	26.5	1.77	19.0
85091104	SUCOFLEX 526S	11 PC35	21 PC35	male/female	1219	48	26.5	2.10	19.0
85089172	SUCOFLEX 526S	11 N	11 N	male/male	1000	39	18	1.43	19.0
85089173	SUCOFLEX 526S	11 SMA	11 SMA	male/male	1000	39	18	1.43	19.0

SUCOFLEX 500

Available connectors

	SUCOFLEX 526S		SUCOFLEX 526V	SUCOFLEX 550S	
	18 GHz	26.5 GHz	26.5 GHz	40 GHz	50 GHz
N straight male	SF_11_N-501				
N straight female	SF_21_N-501				
SMA straight male	SF_11_SMA-501				
PC 3.5 straight male		SF_11_PC35-501			
PC 3.5 straight female		SF_21_PC35-501			
PC 3.5 ruggedised PORT female		SF_21_PC35-502			
PC 3.5 ruggedised PORT female			35VF		
PC 3.5 ruggedised DUT male			35VM		
PC 3.5 DUT female			35F		
SK / 2.92 straight male				SF_11_SK-501	
SK / 2.92 straight female				SF_21_SK-501	
PC 2.4 straight male					SF_11_PC24-501
PC 2.4 straight female					SF_21_PC24-501

Order information

Unlike other similar solutions, the SUCOFLEX 550S is available in tailored lengths and can be delivered within just ten days if the order is up to ten pieces.

For ordering, please follow the instruction below.

Example: SUCOFLEX 550S/11 PC24-501/21 PC24-501/1000mm

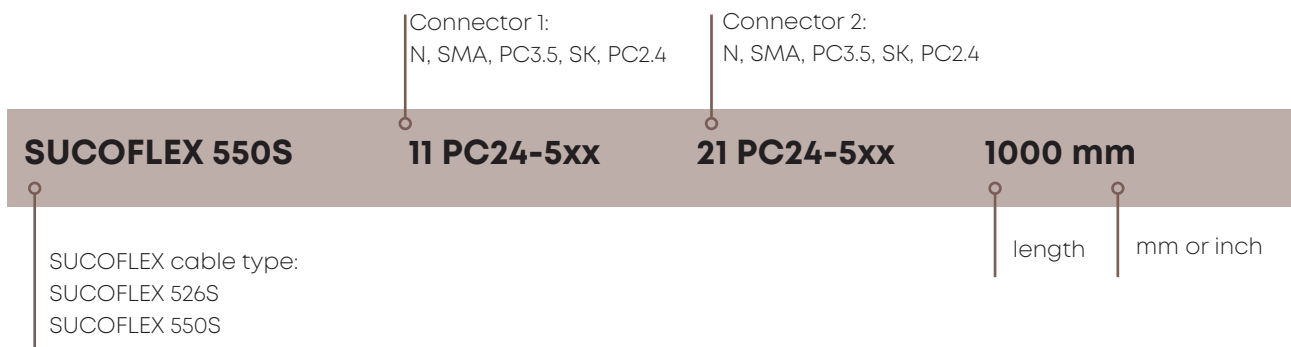

SUCOFLEX 500S

Connector configuration

SF_11_PC24-501
(3.5 mm ruggedised PORT female)

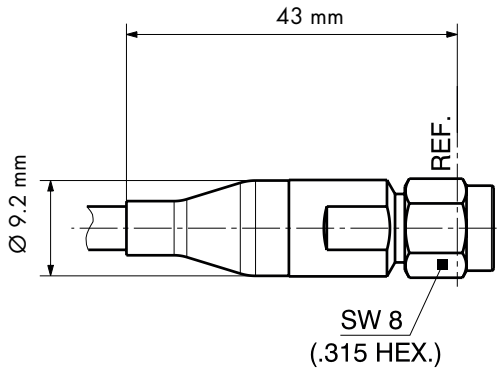

SF_21_PC24-501

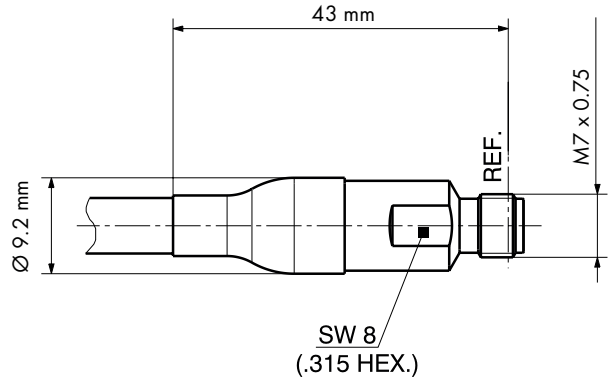

SF_11_SK-501

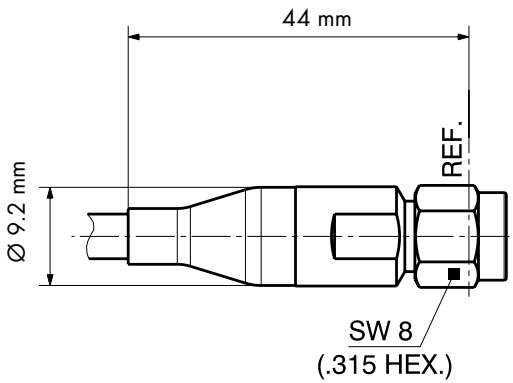

SF_21_SK-501

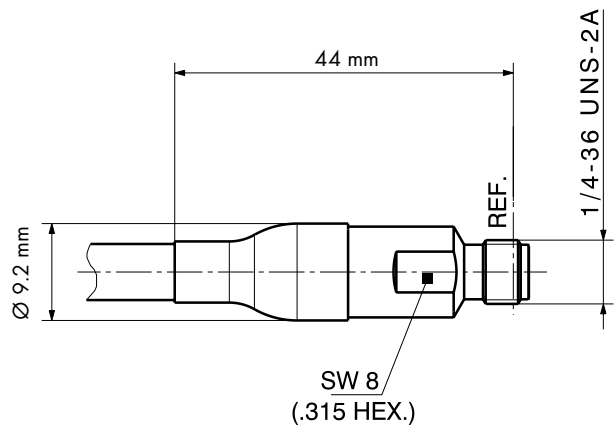

SF_11_PC35-501

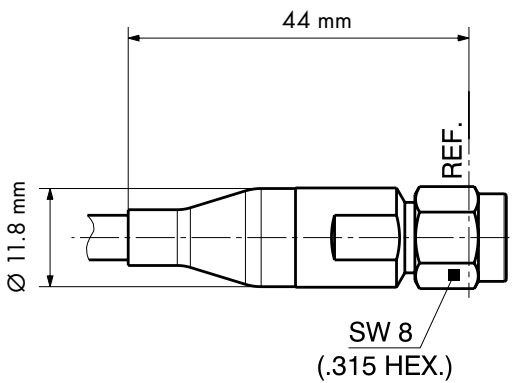

SF_21_PC35-501

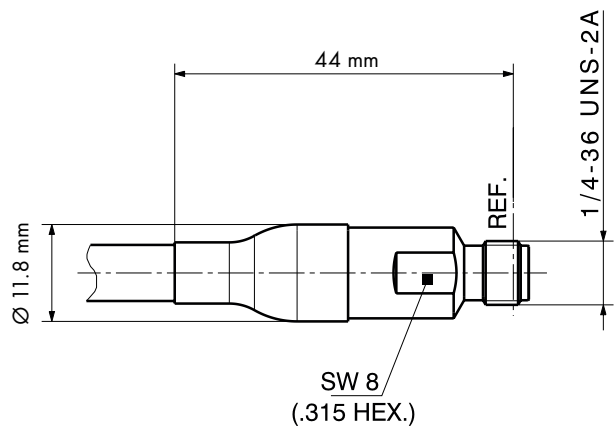

SUCOFLEX 500S

Connector configuration

SF_21_PC35-502

(3.5 mm ruggedised PORT female)

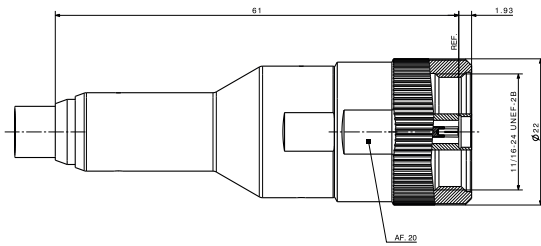

SF_11_SMA-501

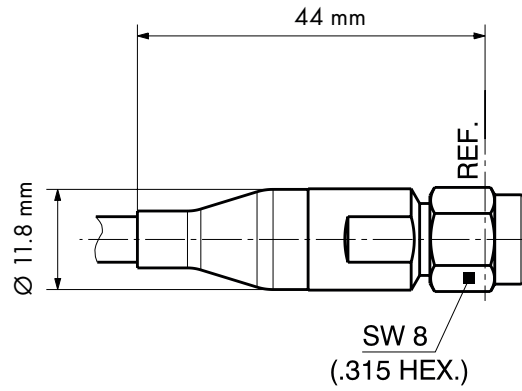

SF_11_N-501

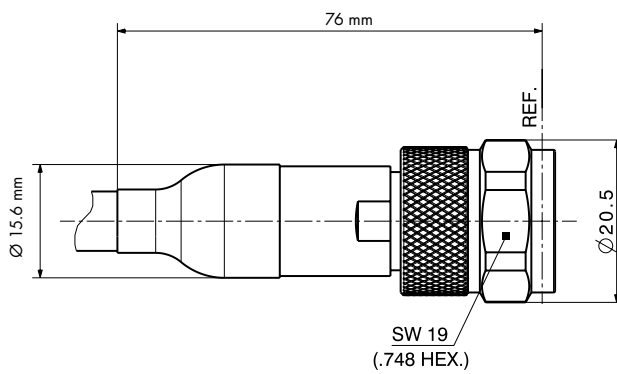

SF_21_N-501

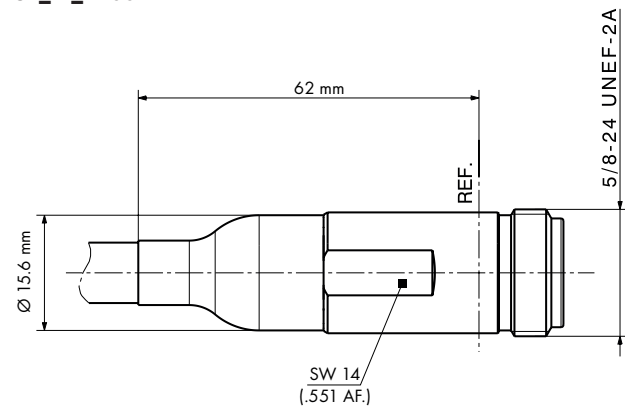

SUCOFLEX 526V

The only VNA microwave cable worldwide with a typical 50 ppm phase variation vs. temperature between +15 and +30 °C. No "PTFE phase knee" at +19 °C as seen on conventional VNA test cable assemblies which cause phase variations and unstable measurements in critical laboratory conditions.



Available assemblies

Product configuration

Art. No.	85069744	85081169	85070046	85081172	85070047	85081177
Cable type	SUCOFLEX 526V					
Length	25" (635 mm)	25" (635 mm)	38" (965 mm)	38" (965 mm)	48" (1219 mm)	48" (1219 mm)
Connector 1	3.5 mm ruggedised PORT female (35VF)					
Connector 2	3.5 mm ruggedised DUT male (35VM)	3.5 mm DUT female (35F)	3.5 mm ruggedised DUT male (35VM)	3.5 mm DUT female (35F)	3.5 mm ruggedised DUT male (35VM)	3.5 mm DUT female (35F)

Mechanical data

Diameter	13 mm
Min. bending radius	50 mm
Crush resistance	80 kN/m
Typ. flex life	> 100 000 cycles 2.0 Mio. for slight movements

Environmental data

Operating temperature	laboratory conditions, analyser specific (+15 to +30 °C)
2011/65/EC (RoHS)	compliant

Electrical data

Art. No.	85069744	85081169	85070046	85081172	85070047	85081177
Impedance	50 Ω					
Operating frequency	up to 26.5 GHz					
Velocity of propagation	80 %					
Time delay	4.15 ns/m					
Return loss	typ. 25 dB min. 20 dB					
Insertion loss	max. 2.5 dB		max. 3.6 dB		max. 4.4 dB	
Min. screening effectiveness	> 90 dB					
Amplitude stability vs. movement	max. 0.05 dB					
Amplitude stability vs. flexure	max. 0.08 dB					
Phase stability vs. flexure	max. 3.9°		max. 7.4°		max. 10°	
Phase stability vs. tensile stress	max. 0.1°/GHz (100 N)					
Phase stability vs. temperature	typ. 50 ppm (+15 to +30 °C)					

Order information

Art. No.	Description
85069744	SF526V/35VF/35VM/25in
85081169	SF526V/35VF/35F/25in
85070046	SF526V/35VF/35VM/38in
85081172	SF526V/35VF/35F/38in
85070047	SF526V/35VF/35VM/48in
85081177	SF526V/35VF/35F/48in

SUCOFLEX 526V

Phase shift vs. temperature (+15 to + 30 °C)

Assembly length (in (mm))	Frequency (GHz)*	SUCOFLEX 526V	Conventional VNA test lead
25 (635)	18	Phase shift /° (for 50 ppm, 80 % VOP)	Phase shift /° (for 700 ppm, 84 % VOP)
25 (635)	26.5	0.9	11.4
25 (635)	26.5	1.3	16.7

*Other frequencies on request

Phase stability vs. temperature performance

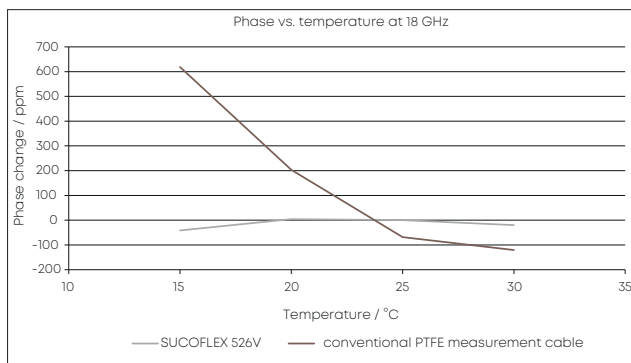

Phase stability vs. flexure

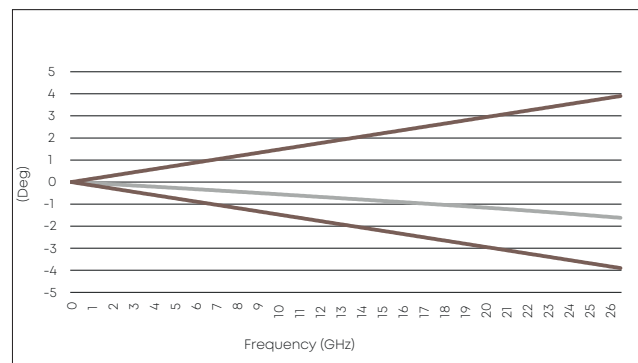

Insertion loss

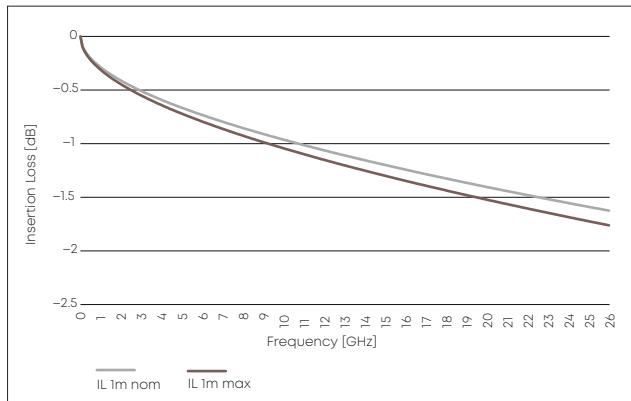

Loss stability vs. flexure

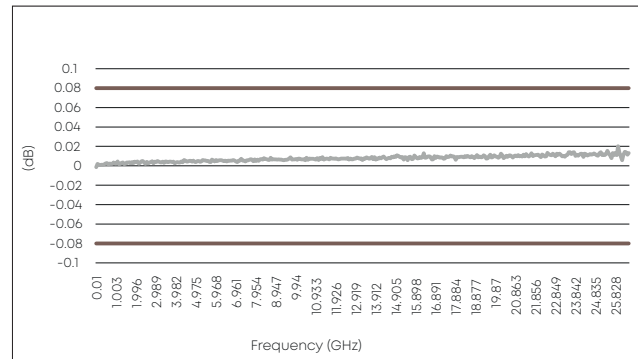

Return loss SUCOFLEX 526V with PC3.5 connectors

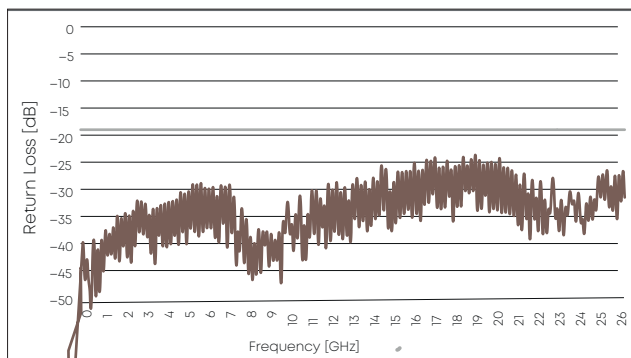

SUCOFLEX 526V

Connector configuration

35VF (3.5 mm ruggedised PORT female)

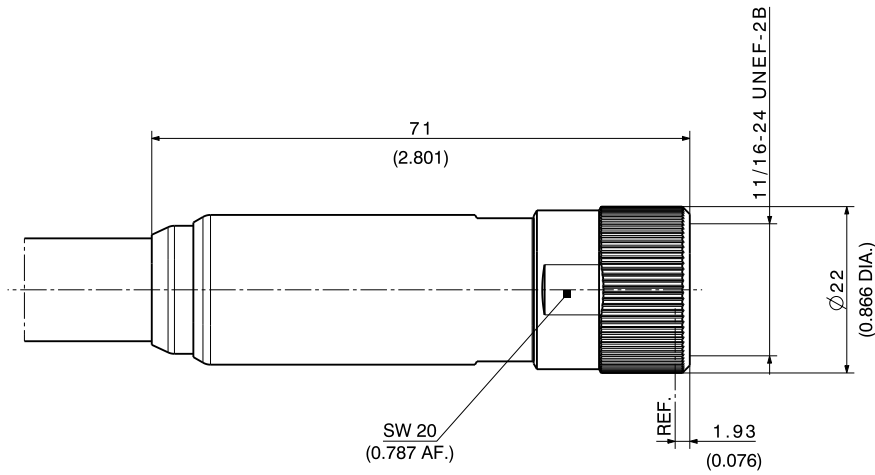

35VF (3.5 mm ruggedised DUT male)

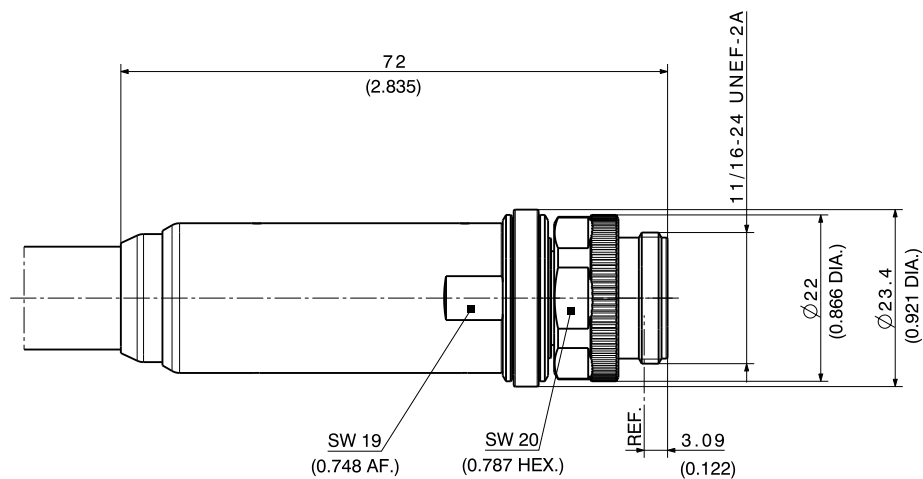

35VF (3.5 mm DUT female)

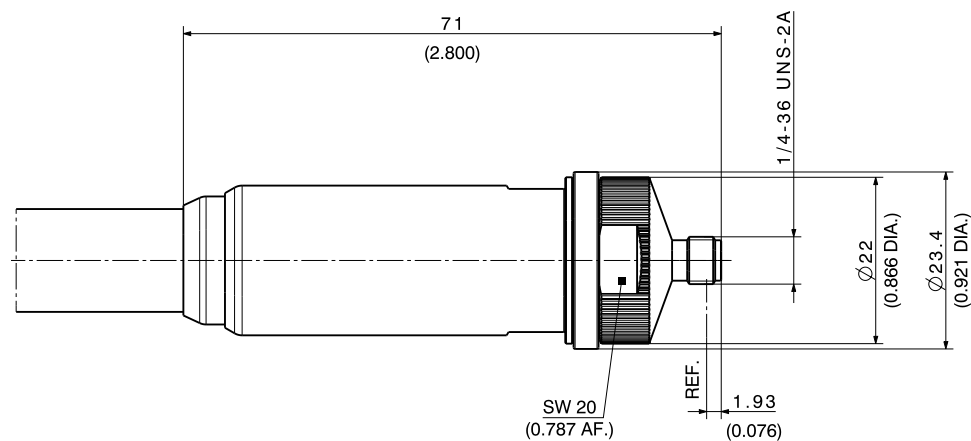

SUCOTEST 18(A)

Sucotest 18 is ideal for daily use in component and assembly shops, test labs, and high speed digital testing applications.

Sucotest 18A armoured test assemblies are ideal for testing wireless communication infrastructures and outdoor use.



Features and benefits

- Applicable up to 18.0 GHz
- Low insertion loss
- Excellent VSWR
- Unique loss stability
- High flexibility despite of armouring
- Phase and loss stability with flexure
- Crush-, torque and kink-resistant
- Waterproof IP68

Recommended connectors

ST_18	SMA, QMA, N
ST_18A	N, 7/16

Specifications

Frequency range	2 GHz	2.01 – 4 GHz	4.01 – 6 GHz	6.01 – 12 GHz	12.01 – 18 GHz
Power handling 25 °C, sea level (W)	> 391	> 277	> 225	> 160	> 131
Return loss (dB)	> 30	>28	> 25	> 21	> 19
Insertion loss stability vs. shaking (dB)	< 0.03	< 0.03	< 0.03	< 0.03	< 0.03
Insertion loss stability vs. bending (dB)	< 0.03	< 0.04	< 0.04	< 0.05	< 0.05
Insertion loss stability vs. torsion (dB)	< 0.03	< 0.04	< 0.04	< 0.05	< 0.05

Product assortment

Item no.	Type	Length	Frequency	Max. insertion los	Max. VSWR	ROHS compliant
		mm/inch	GHz	at 25 °C		
84002061	ST-18/SMAm/SMAm/36 inch	914/36	18	< 1.51		
84002060	ST-18/Nm/Nm/36 inch	914/36	18	< 1.51		
84004594	ST-18/SMAm/Nm/36 inch	914/36	18	< 1.51		
84003373	ST-18/SMAm/SMAm/48 inch	1219/48	18	< 1.95		
84003372	ST-18/Nm/Nm/48 inch	1219/48	18	< 1.95		
84004006	ST-18/SMAm/Nm/48 inch	1219/48	18	< 1.95		
84004007	ST-18/SMAm/SMAm/72 inch	1829/72	18	< 2.85		
84004070	ST-18/Nm/Nm/72 inch	1829/72	18	< 2.85		
84004595	ST-18/SMAm/Nm/72 inch	1829/72	18	< 2.85		
84013029	ST18A/Nm/Nm/1500 mm	1500	18	2.74	1.25	yes
84013030	ST18A/Nm/Nf/1500 mm	1500	18	2.74	1.25	yes
84013031	ST18A/Nm/Nm/3000 mm	3000	18	5.30	1.25	yes
84013032	ST18A/Nm/Nf/3000 mm	3000	18	5.30	1.25	yes
84013033	ST18A/Nm/716f/1500 mm	1500	7.5	1.65	1.29	yes
84013034	ST18A/Nm/716f/1500 mm	1500	7.5	1.65	1.29	yes
84013035	ST18A/Nm/716m/3000 mm	3000	7.5	3.18	1.29	yes
84013036	ST18A/Nm/716f/3000 mm	3000	7.5	3.18	1.29	yes

SUCOTEST 18(A)

Attenuation (nominal values at +25 °C ambient temperature)

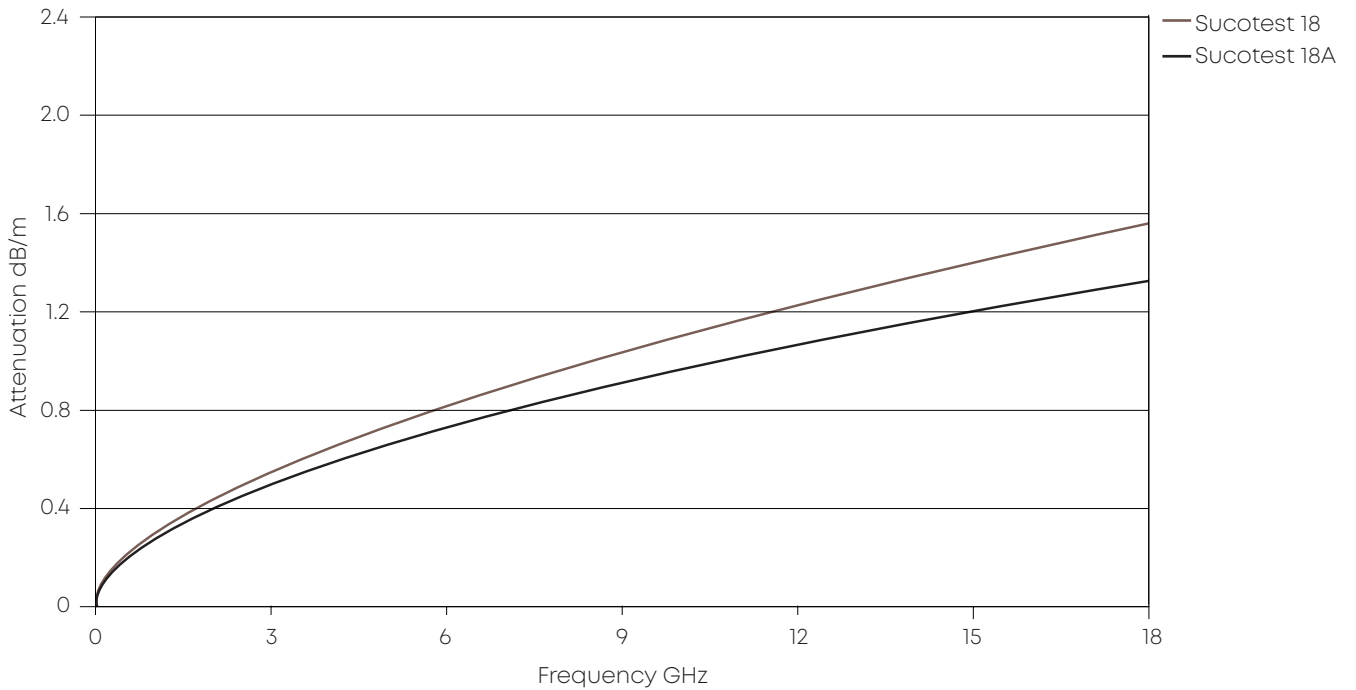

Power handling (maximum values at 25 °C ambient temperature and sea level)

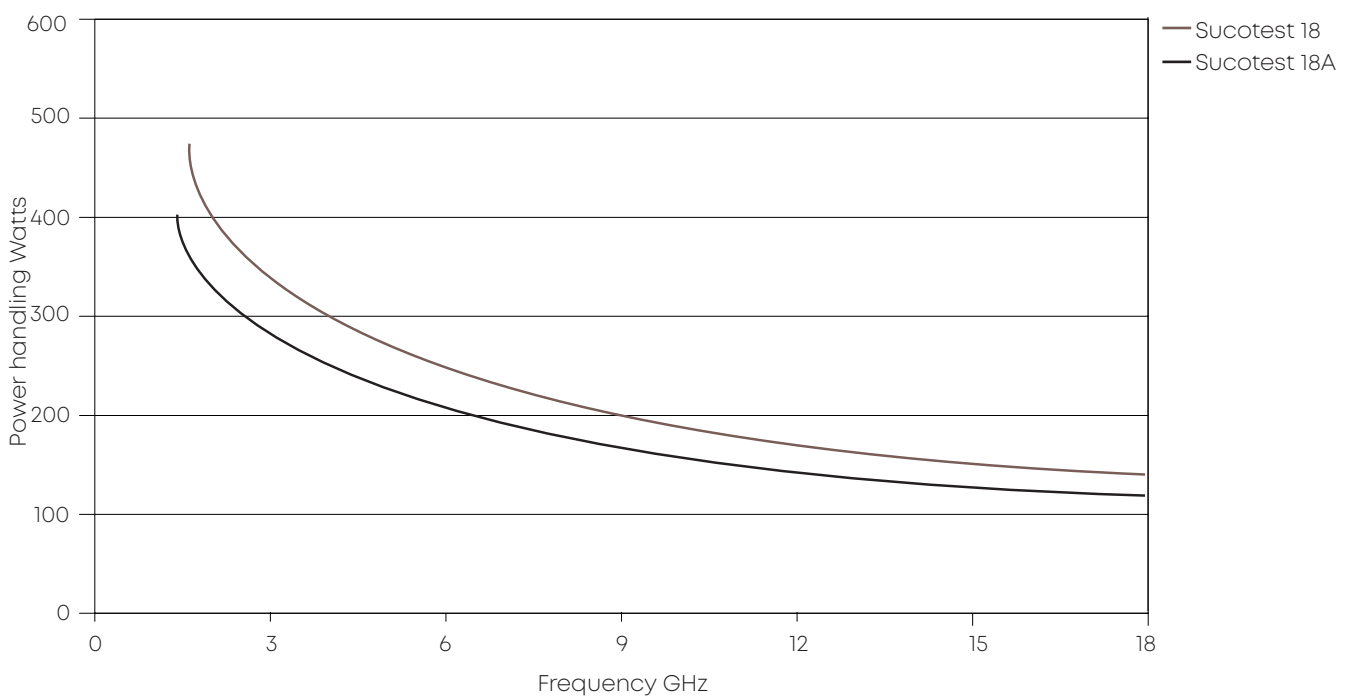

SUCOTEST 26/SUCOTEST 40

The test lead up to 26/40 GHz

Product description

Sucotest 26/Sucotest 40 cable assemblies are high frequency, low loss cables which are five shielded for superior RF isolation. The internal stainless steel outer braid provides higher pull strength and lighter weight than RG style cable. Nomex and polyolefin jackets are also available.



Product features

- Impedance 50 Ω
- Applicable up to 26/40 GHz
- Amplitude stability: < 0.1 dB at 26.5 GHz for 200 flexes 180° in one plane around a 2" radius, 0.2 dB with 600 flexes
- Five shields for super RF shielding (-120 dB)
- Steel outer shield for high pull strength
- Low cost, available from stock

Recommended connectors

ST26	SMA
ST40	SK

Construction

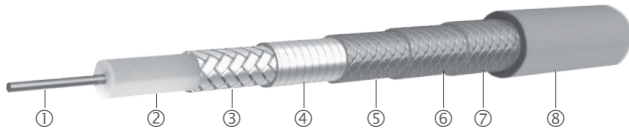

Cable	Inner conductor ①	Dielectric ②	Outer conductor ③	Barrier ④	Outer braid ⑤	Outer braid ⑥	Outer braid ⑦	Outer jacket ⑧	Outer diameter mm
Sucotest_26	CuAg wire	PTFE microporous	CuAg flat wire braid	aluminum/polyimide tape	stainless steel	CuAg	CuAg	FEP, blue	4.8
Sucotest_40									

Technical data

Cable	Max. operating frequency	Velocity of propagation	Weight	Min. bending radii		Temperature range
	GHz	%	g/m	static mm	repeated mm	
Sucotest_26	26	76.3	62.5	17.8	53.3	-55 to +200
Sucotest_40	40	76.3	62.5	17.8	53.3	-55 to +200

SUCOTEST 26/SUCOTEST 40

Attenuation (nominal values at +25 °C ambient temperature)

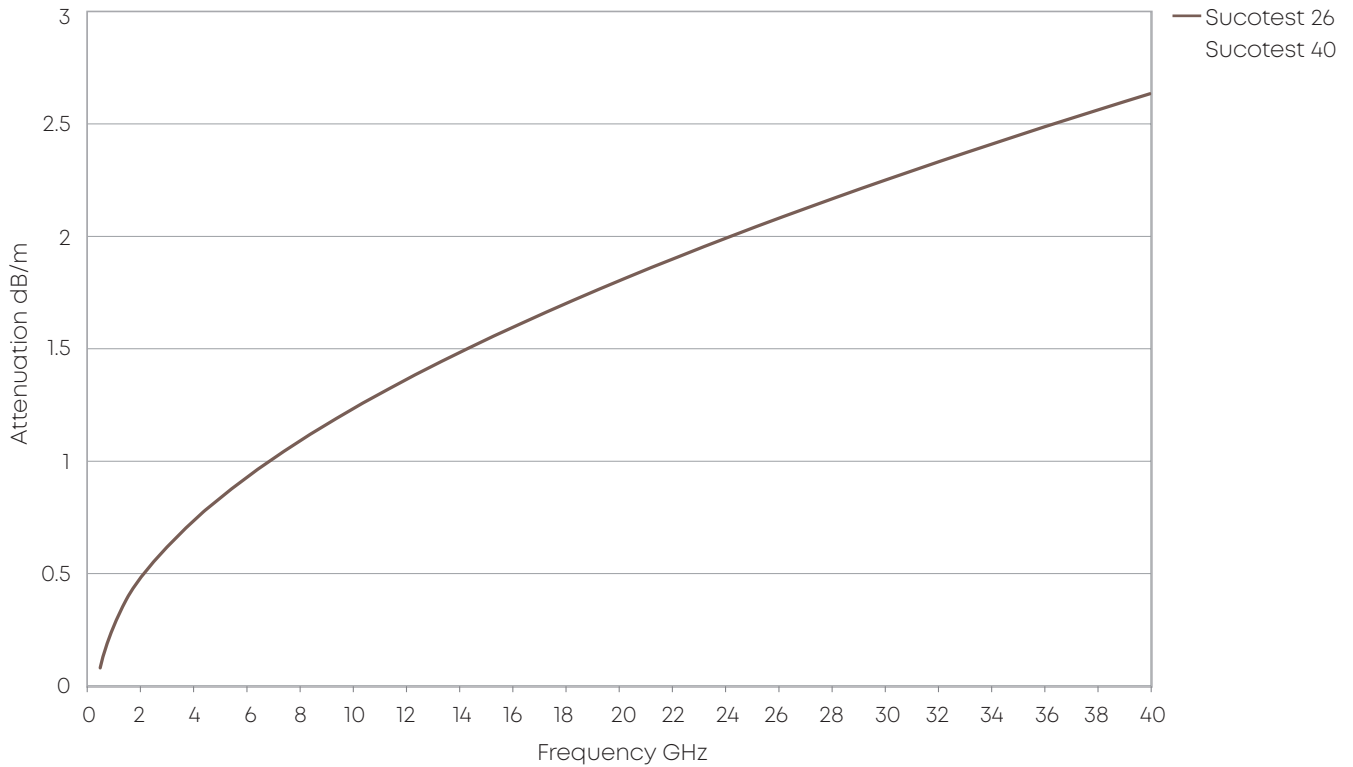

Power handling (maximum values at 25 °C ambient temperature and sea level)

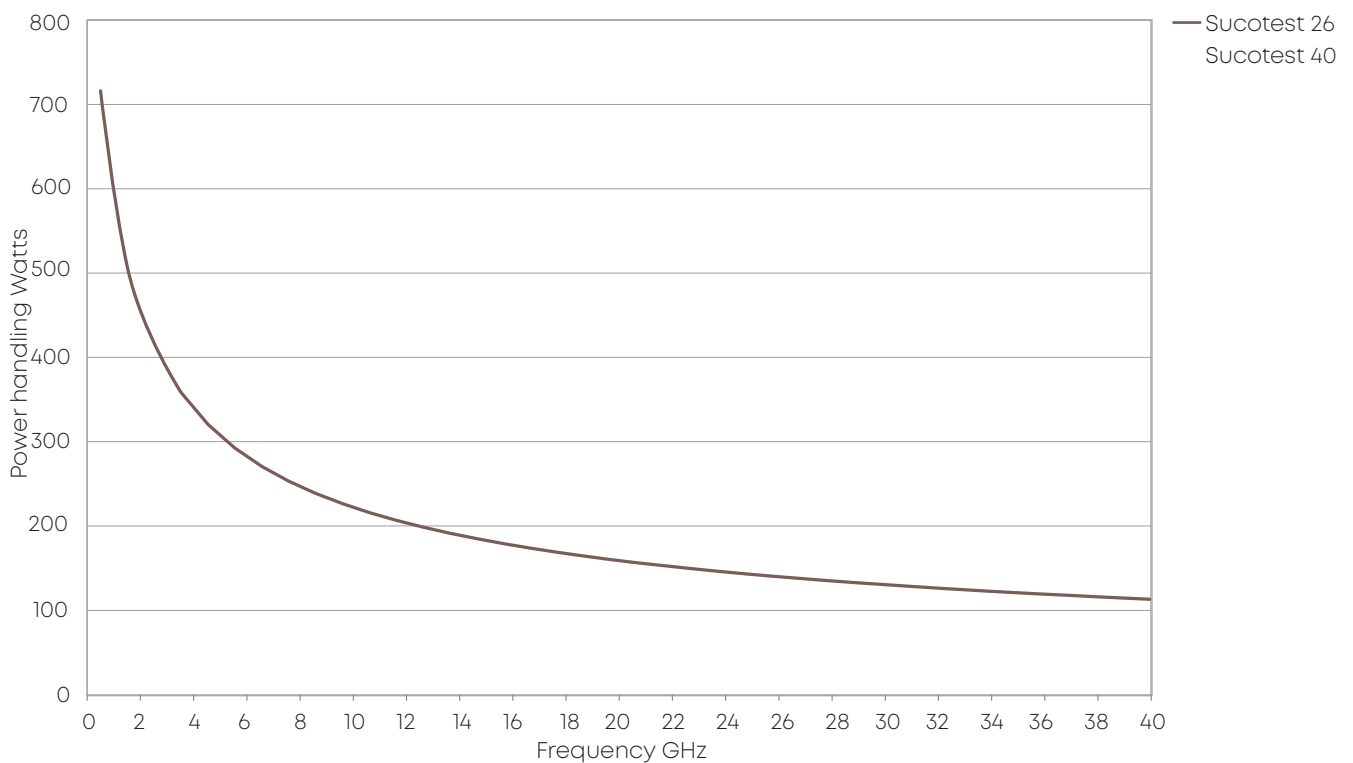

Stock assemblies

Sucotest 18 (A)

Item no.	Type	Length		Frequency	Max. insertion loss at 25 °C	Max. VSWR	ROHS comp.
		mm	inch	GHz			
84002061	ST-18/SMAm/SMAm/36 inch	914	36	18	< 1.51		
84002060	ST-18/Nm/Nm/36 inch	914	36	18	< 1.51		
84004594	ST-18/SMAm/Nm/36 inch	914	36	18	< 1.51		
84003373	ST-18/SMAm/SMAm/48 inch	1219	48	18	< 1.95		
84003372	ST-18/Nm/Nm/48 inch	1219	48	18	< 1.95		
84004006	ST-18/SMAm/Nm/48 inch	1219	48	18	< 1.95		
84004007	ST-18/SMAm/SMAm/72 inch	1829	72	18	< 2.85		
84004070	ST-18/Nm/Nm/72 inch	1829	72	18	< 2.85		
84004595	ST-18/SMAm/Nm/72 inch	1829	72	18	< 2.85		
84013029	ST18A/Nm/Nm/1500 mm	1500	59	18	2.74	1.25	yes
84013030	ST18A/Nm/Nf/1500 mm	1500	59	18	2.74	1.25	yes
84013031	ST18A/Nm/Nm/3000 mm	3000	118	18	5.30	1.25	yes
84013032	ST18A/Nm/Nf/3000 mm	3000	118	18	5.30	1.25	yes

Sucotest 26/40

Item no.	Type	Length		Frequency	Max. insertion loss at 25 °C	Max. VSWR	RoHS compliant
		mm	inch	GHz	dB		
80391541	ST26/SMAm/SMAm/24 inch	610	24	26.5	1.74	1.45	yes
80391542	ST26/SMAm/SMAm/36 inch	914	36	26.5	2.41	1.45	yes
80391543	ST26/SMAm/SMAm/48 inch	1219	48	26.5	3.08	1.45	yes
80391545	ST40/SKm/SKm/24 inch	610	24	40	2.20	1.50	yes
80391546	ST40/SKm/SKm/36 inch	914	36	40	3.03	1.50	yes
80391547	ST40/SKm/SKm/48 inch	1219	48	40	3.87	1.50	yes

MINIBEND series



The goal of the MINIBEND series is to provide the user with incredible flexibility in both cable assembly configurations and applications.

These cables incorporate numerous features that give them the smallest bend radii in the industry without compromising isolation, stability or durability. Our connectors complement this series with a patented design that eliminates soldering and strain relief on the cable allowing for the minimum bend radius at the connector. Whether the project requires low loss, high frequency or high isolation, small connectors or small bend radii, our qualified MINIBEND series of cable assemblies will exceed your requirements.

- Light weight and low profile
- Aerospace qualification heritage
- Available as low loss and highly phase stable cables
- Solderless cable junction design

MINIBEND/MICROBEND

Low profile, high performance flexible microwave coaxial cable assemblies with solderless joints, eliminates need for costly and space-consuming right angle connectors.

- Frequency range up to 85 GHz
- Triple shielded for high isolation
- Solid PTFE dielectric
- Direct replacement for 0.086 and 0.047 inch semi-rigid cables



MINIBEND L/MICROBEND L/Mini141

Low loss, high performance, flexible microwave coaxial cable assemblies with 30 % reduction in insertion loss as compared to the solid PTFE dielectric counterparts.

- Frequency range up to 65 GHz
- Triple shielded for high isolation
- Low density PTFE dielectric
- Low loss replacement for .047, .086 and .141 inch size cables



MINIBEND CTR

The MINIBEND CTR family combines the industry-renowned flexibility of HUBER+SUHNER Astrolab's bend-to-the-end connector termination technology with industry leading phase vs. temperature performance.

- Frequency range up to 70 GHz
- Triple shielded for high isolation
- Foamed PFA Dielectric
- Eliminates need for costly right angle connectors



MINIBEND H/MINIBEND LH/Mini141 H

Ultra-low loss microwave cable assemblies and optional ECTFE jacket for highest radiation resistance.

- Frequency range up to 85 GHz
- 5 shields for improved isolation
- Solid and Low density PTFE dielectric
- Up to 200Mrad radiation resistance when using ECTFE jacket



MINIBEND series

Standard

All cables utilise triple shields for superior RF shielding, with a solid PTFE dielectric for exceptional crush resistance without the need for heavy armour. The flat wire braid outer conductor provides low loss plus excellent insertion loss stability versus flexure. The stainless steel outer braid provides improved mechanical pull strength when compared to cables with a copper wire outer braid.

- Aerospace qualification heritage
- Smallest bending radii
- Steel outer shield for high pull strength
- Solid PTFE dielectric for exceptional crush resistance without the need for heavy armour

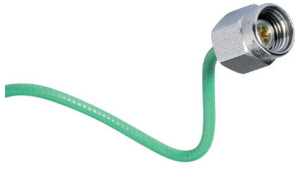
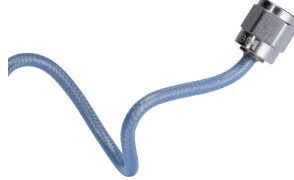
	MICROBEND R	MINIBEND R
		
Electrical specifications		
Impedance (nominal)	50 Ω	50 Ω
Velocity %	70	70
Operating frequency	DC – 85 GHz	DC – 65 GHz
Insertion loss variation vs. temperature	< 0.003 °K ⁻¹	< 0.003 °K ⁻¹
Return loss (min)	-32 dB @ 18 GHz -25 dB @ 40 GHz	-32 dB @ 18 GHz -25 dB @ 40 GHz
RF leakage	110 dB	110 dB
Resistance – insulation cable	> 10 ⁶ MΩ*m	> 10 ⁶ MΩ*m
Withstand voltage – cable assembly (at sea level)	> 1300 V	> 2000 V
Capacitance	97.4 pF*m ⁻¹	98.4 pF*m ⁻¹
Time delay	4.76 ns*m ⁻¹	4.76 ns*m ⁻¹
Phase variation vs. temperature	< 6000 ppm	< 6000 ppm
Materials and finishes		
Cable center conductor	silver plated OFHC copper	silver plated OFHC copper
Cable dielectric	solid PTFE	solid PTFE
Cable shield	silver plated copper flat wire braid	silver plated copper flat wire braid
Cable binder	aluminum/polyimide laminate tape	aluminum/polyimide laminate tape
Cable braid	stainless steel round wire braid	stainless steel round wire braid
Cable jacket	extruded FEP	extruded FEP
Cable mechanics		
Diameter	1.91 mm	2.49 mm
Minimum bending radius – static	1.52 mm	5.08 mm
Minimum bending radius – dynamic	4.57 mm	15.24 mm
Cable retention force on ruggedized cable assemblies	45 N	111 N
Weight	9.2 g*m ⁻¹	14.6 g*m ⁻¹
Environmental specification		
Temperature range	-65 to +150 °C	-65 to +150 °C
Radiation resistance	30 Mrad	30 Mrad
Out gassing according ECSS-Q-ST-70-02 and NASA reference publication 1124	TML < 1 %, CVCM < 0.1 %	TML < 1 %, CVCM < 0.1 %



MINIBEND L – series

Low loss cable assemblies

MINIBEND L is an enhanced, low loss version of the MINIBEND flexible coaxial cable assemblies. Designed to be used in low profile, internal, point-to-point interconnections between RF modules within communications systems. The low loss cable family offers 0.047, 0.086 and 0.141 inch alternatives providing 30% lower attenuation than the standard flexible cables. MINIBEND L, mini141 and microbend L have Microporous PTFE dielectric providing improved phase characteristics, such as phase versus flexure and phase versus temperature. These cables are available in a variety of preassembled configurations, tested for high performance, cost-effective alternative in a range of standard lengths.

- Microporous PTFE for superior electrical performance
- Excellent phase and IL stability over flexure
- Aerospace heritage with standard assemblies
- Light weight and low profile

	Mini141	MINIBEND LR	MICROBEND LR
			
Electrical specifications			
Impedance (nominal)	50 Ω	50 Ω	50 Ω
Velocity %	76	76	76
Operating frequency	DC – 40 GHz	DC – 50 GHz	DC – 65 GHz
Insertion loss variation vs. temperature	< 0.0015 °K ⁻¹	< 0.0015 °K ⁻¹	< 0.0015 °K ⁻²
Return loss (min)	-28 dB @ 18 GHz -20 dB @ 40 GHz	-28 dB @ 18 GHz -20 dB @ 40 GHz	-28 dB @ 18 GHz -20 dB @ 40 GHz
RF leakage	110 dB	110 dB	110 dB
Resistance – insulation cable	> 10 ⁶ MΩ*m	> 10 ⁶ MΩ*m	> 10 ⁶ MΩ*m
Withstand voltage – cable assembly (at sea level)	> 5000 V	> 2000 V	> 1300 V
Capacitance	89.2 pF*m ⁻¹	90.2 pF*m ⁻²	85.1 pF*m ⁻²
Time delay	4.39 ns*m ⁻¹	4.39 ns*m	4.39 ns*m ⁻²
Phase variation vs. temperature	< 1500 ppm	< 1500 ppm	< 1500 ppm
Materials and finishes			
Cable center conductor	silver plated OFHC copper	silver plated OFHC copper	silver plated OFHC copper
Cable dielectric	microporous PTFE	microporous PTFE	microporous PTFE
Cable shield	silver plated copper flat wire braid	silver plated copper flat wire braid	silver plated copper flat wire braid
Cable binder	aluminum/polyimide laminate tape	aluminum/polyimide laminate tape	aluminum/polyimide laminate tape
Cable braid	stainless steel round wire braid	stainless steel round wire braid	stainless steel round wire braid
Cable jacket	extruded FEP	extruded FEP	extruded FEP
Cable mechanics			
Diameter	3.61 mm	2.64 mm	2.03 mm
Minimum bending radius – static	8.38 mm	6.4 mm	5.10 mm
Minimum bending radius – dynamic	25.15 mm	19.1 mm	15.20 mm
Cable retention force on ruggedized cable assemblies	111 N	111 N	45 N
Weight	28.5 g*m ⁻¹	15.5 g*m ⁻¹	10.4 g*m ⁻¹
Environmental specification			
Temperature range	-65 to +150 °C	-65 to +150 °C	-65 to +150 °C
Radiation resistance	30 Mrad	30 Mrad	30 Mrad
Out gassing according ECSS-Q-ST-70-02 and NASA reference publication 1124	TML < 1 %, CVCM < 0.1 %	TML < 1 %, CVCM < 0.1 %	TML < 1 %, CVCM < 0.1 %

MINIBEND L – graphs

Attenuation (nominal values at +25 °C ambient temperature)

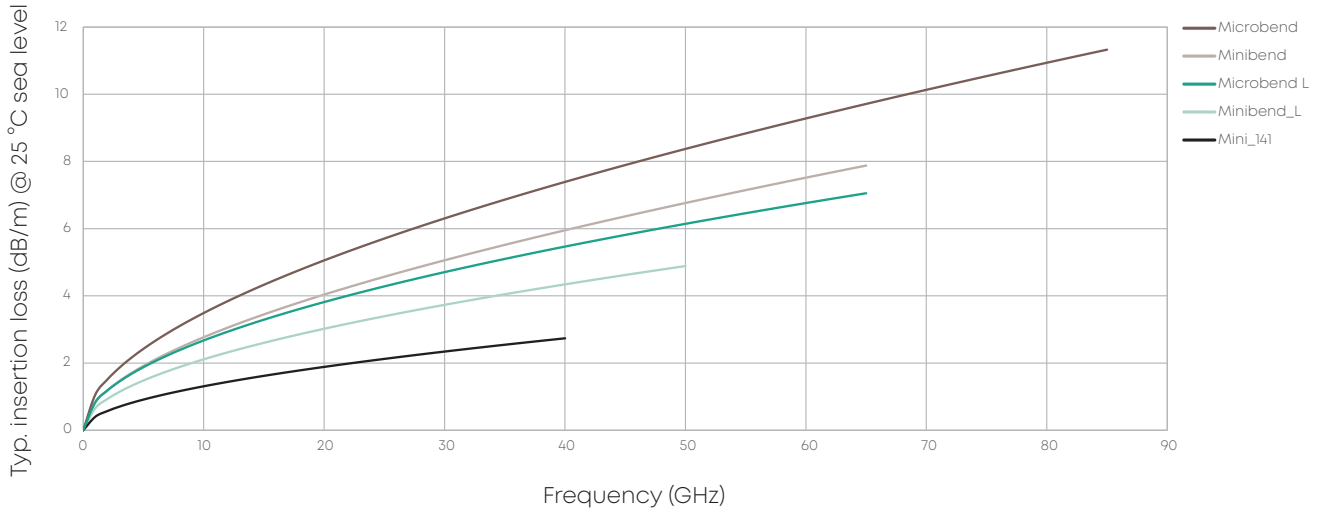

Power handling (maximum values at 25 °C ambient temperature and sea level)

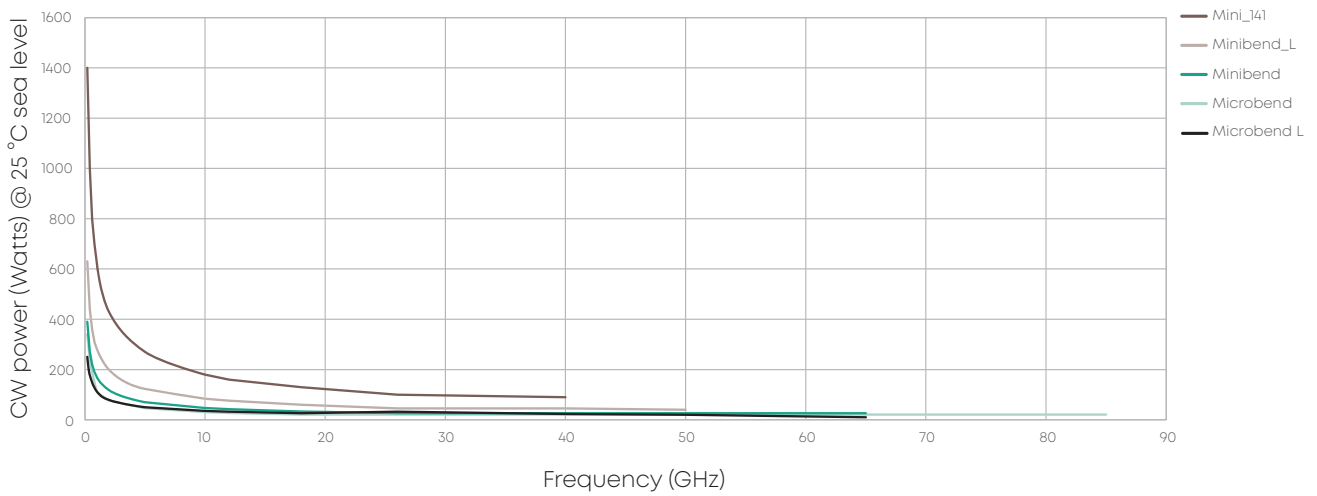

MINIBEND CTR – phase invariant cable assemblies

Phase invariant cable assemblies

The MINIBEND CTR family of cable assemblies combines the industry-renowned flexibility of HUBER+SUHNER Astrolab's solderless bend-to-the end connector termination technology with industry leading phase vs. temperature performance to create a stable, reliable, MIL-DTL-17 qualified interconnect solution to satisfy an endless range of customer applications where phase stability is key. The broad selection of connector interfaces offered on phase invariant cable assemblies ensures that we are able to meet the unique requirements of our customers.

- Increased system accuracy over temperature change
- Flat phase change over temperature
- Bend-to-the end technology
- Outstanding return loss performance
- Higher reliability due to solderless junctions

MINIBEND CTR	
	
Electrical specifications	
Impedance (nominal)	50 Ω
Velocity %	80
Operating frequency	DC – 70 GHz
Insertion loss variation vs. temperature	< 0.004 $^{\circ}\text{K}^{-1}$
Return loss (min)	-32 dB @ 18 GHz
	-25 dB @ 40 GHz
RF leakage	110 dB
Resistance – insulation cable	> 10 ⁶ M Ω *m
Withstand voltage – cable assembly (at sea level)	> 1200 V
Capacitance	83.3 pF*m ⁻¹
Time delay	4.17 ns*m ⁻¹
Phase variation vs. temperature	< 300 ppm
Materials and finishes	
Cable center conductor	silver plated solid OFHC copper
Cable dielectric	foamed PFA
Cable shield	silver plated copper flat wire braid
Cable binder	aluminum/polyimide laminate tape
Cable braid	stainless steel round wire braid
Cable jacket	extruded FEP
Cable mechanics	
Diameter	2.49 mm
Minimum bending radius – static	5.08 mm
Minimum bending radius – dynamic	15.24 mm
Cable retention force on ruggedized cable assemblies	111 N
Weight	14.9 g*m ⁻¹
Environmental specification	
Temperature range	-65 to +150 $^{\circ}\text{C}$
Radiation resistance	30 Mrad
Out gassing according ECSS-Q-ST-70-02 and NASA reference publication 1124	TML < 1 %, CVCM < 0.1 %

MINIBEND CTR – graphs

Attenuation (nominal values at +25 °C ambient temperature)

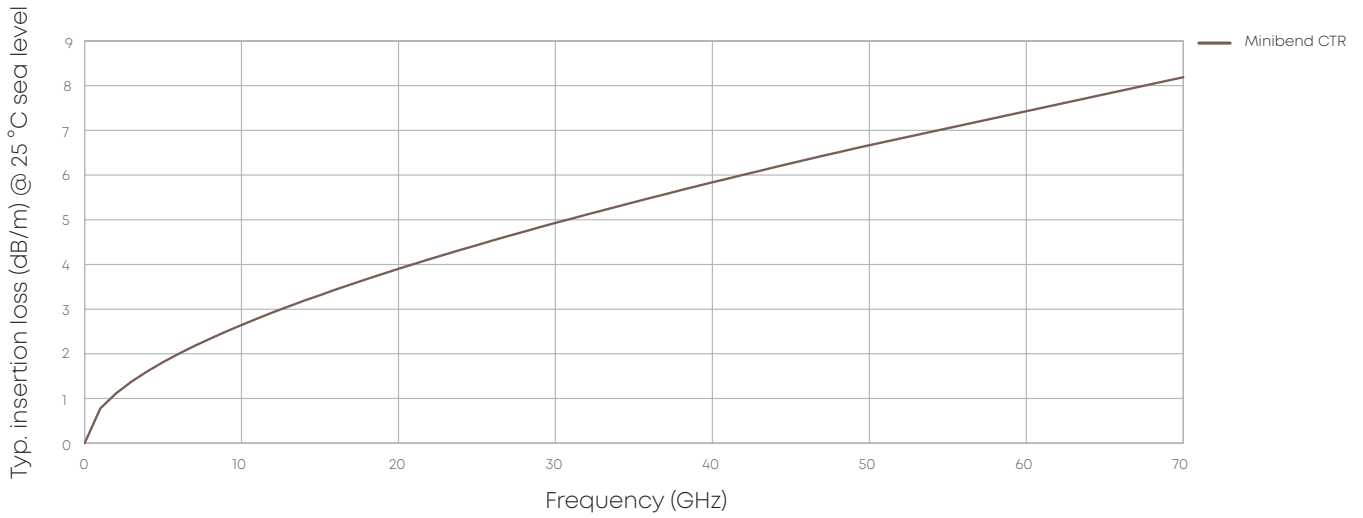

Power handling (maximum values at 25 °C ambient temperature and sea level)

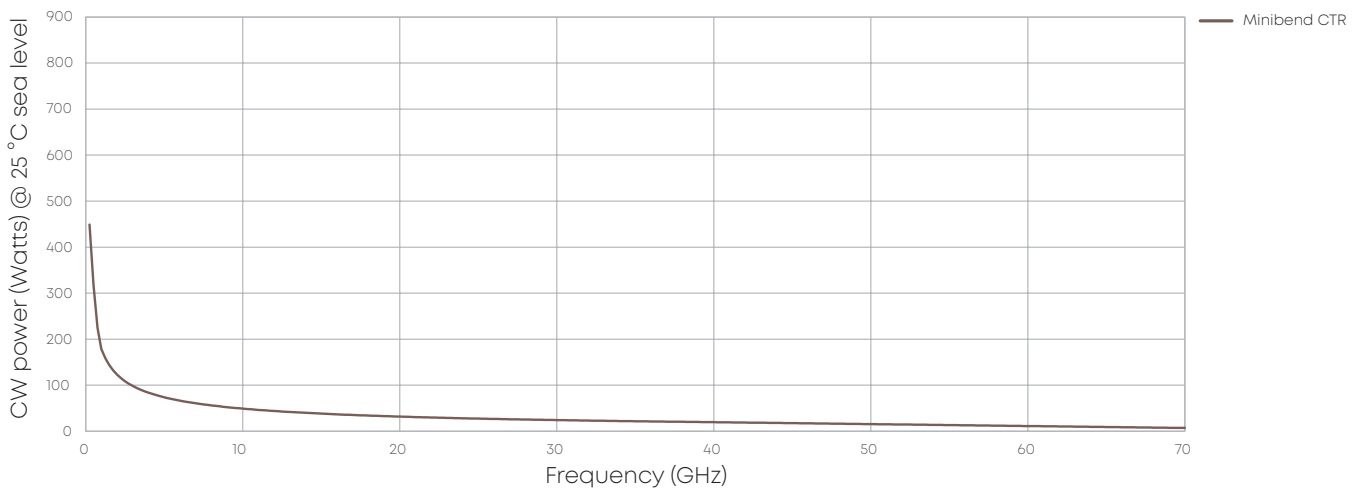

Phase stability versus temperature

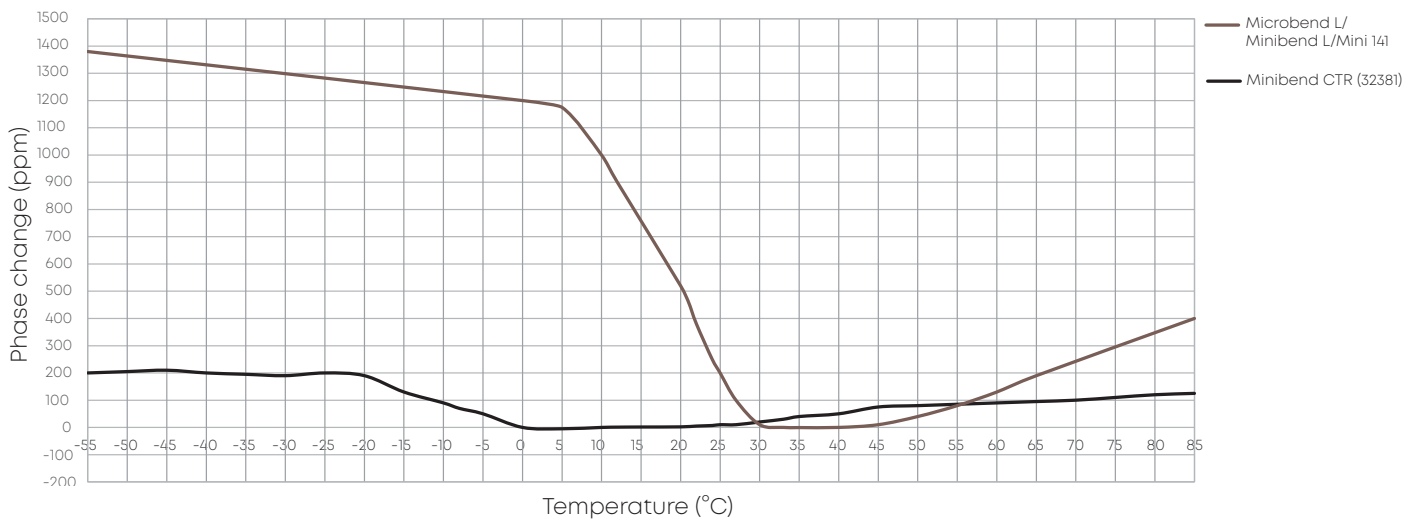

MINIBEND H – high shielded cable assemblies

HUBER+SUHNER extends the RF cable assembly portfolio with a highly shielded and ultra-low loss cables for space and defense applications. The MINIBEND H series offer a frequency range up to 85 GHz .

- Five shields for high isolation
- ECTFE jacket option (B) for high radiation resistant (200 Mrad)
- Solderless junctions for highest reliability
- Outstanding return loss performance

	MINIBEND H(B)	MINIBEND LH(B)R	Mini141H(B)
			
Electrical specifications			
Impedance (nominal)	50 Ω	50 Ω	50 Ω
Velocity %	70	76	76
Operating frequency	DC – 85 GHz	DC – 65 GHz	DC – 45 GHz
Insertion loss variation vs. temperature	< 0.003 °K ⁻¹	< 0.0015 °K ⁻¹	< 0.0015 °K ⁻¹
Return loss (min)	-32 dB @ 18 GHz	-28 dB @ 18 GHz	-28 dB @ 18 GHz
	-25 dB @ 40 GHz	-20 dB @ 40 GHz	-20 dB @ 40 GHz
RF leakage	130 dB	130 dB	130 dB
Resistance – insulation cable	> 10 ⁶ MΩ*m	> 10 ⁶ MΩ*m	> 10 ⁶ MΩ*m
Withstand voltage – cable assembly (at sea level)	> 1300 V	> 1300 V	> 5000 V
Capacitance	97.4 pF*m ⁻¹	85.1 pF*m ⁻¹	89.5 pF*m ⁻¹
Time delay	4.76 ns*m ⁻¹	4.39 ns*m ⁻¹	4.39 ns*m ⁻¹
Phase variation vs. temperature	< 6000 ppm	< 1500 ppm	< 1500 ppm
Materials and finishes			
Cable center conductor	silver plated solid OFHC copper	silver plated solid OFHC copper	silver plated solid OFHC copper
Cable dielectric	PTFE	expanded PTFE	expanded PTFE
Cable shield	silver plated OFCP flat wire copper braid	silver plated OFCP flat wire copper braid	silver plated OFCP flat wire copper braid
Cable binder	aluminum/polyimide laminate tape	aluminum/polyimide laminate tape	aluminum/polyimide laminate tape
Cable braid	stainless steel round wire braid	stainless steel round wire braid	stainless steel round wire braid
Cable braid	silver plated copper clad steel wire braid	silver plated copper clad steel wire braid	silver plated copper clad steel wire braid
Cable braid	silver plated copper clad steel wire braid	silver plated copper clad steel wire braid	silver plated copper clad steel wire braid
Cable jacket	extruded FEP (extruded ECTFE)	extruded FEP (extruded ECTFE)	extruded FEP (extruded ECTFE)
Cable mechanics			
Diameter	2.49 mm	2.54 mm	3.61 mm
Minimum bending radius – static	5.08 mm	5.08 mm	8.4 mm
Minimum bending radius – dynamic	15.24 mm	15.24 mm	25.2 mm
Cable retention force on ruggedized cable assemblies	111 N	111 N	111 N
Weight	18.1 g*m ⁻¹	18.1 g*m ⁻¹	40.5 g*m ⁻¹
Environmental specification			
Temperature range	-65 to +150°C	-65 to +150°C	-65 to +150°C
Radiation resistance	30 Mrad (200 Mrad)	30 Mrad (200 Mrad)	30 Mrad (200 Mrad)
Out gassing according ECSS-Q-ST-70-02 and NASA reference publication 1124	TML < 1 %, CVCM < 0.1 %	TML < 1 %, CVCM < 0.1 %	TML < 1 %, CVCM < 0.1 %

MINIBEND H – graphs

Attenuation (nominal values at +25 °C ambient temperature)

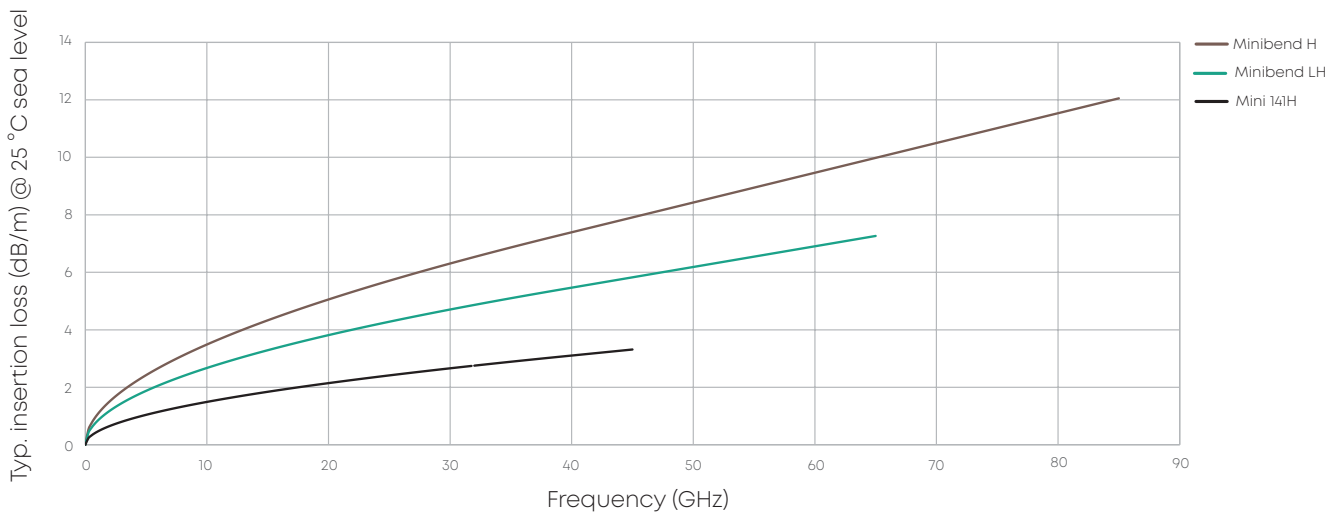

Power handling (maximum values at 25 °C ambient temperature and sea level)

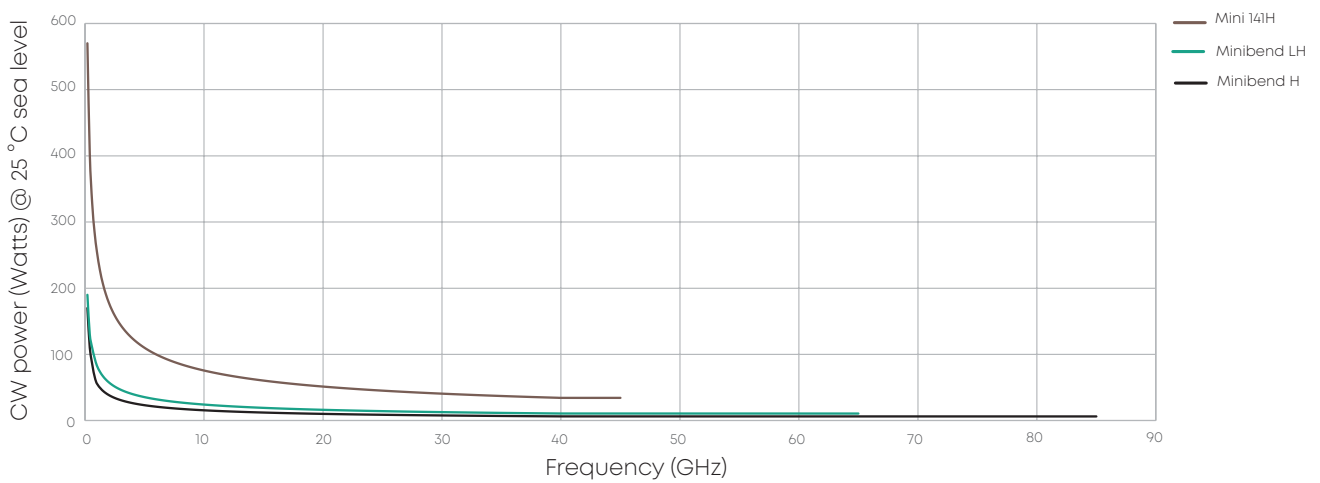

Qualifications

The entire MINIBEND family is certified to the following standards through testing, analysis or similarity.

Cable qualification

MIL-DTL-17

Connector qualification

MIL-PRF-39012

MIL-PRF-31031 (SMP)

Cable assembly qualification

MIL-PRF-55427

Space qualification

MIL-STD-1547

NASA EEE-INST-002

ESA 3902

ESA 3402

Thermal shock

MIL-STD-202, method 107, test condition A, 1000 cycles,
with cable bent at min. bend radius

Mechanical shock

MIL-STD-202, method 213, 12 000 g peak

MIL-STD-883, method 2002, 1500 g peak

Sinusoidal vibration

MIL-STD-202, method 204, 28 g peak

Random vibration

MIL-STD-202, method 214, 46.3 g rms

MIL-STD-883, method 2026, 16.4 g rms

Acceleration

MIL-STD-883, method 2001, 3000 g peak

Moisture resistance

MIL-STD-202, method 106

Corrosion

MIL-STD-202, method 101, test condition B

Semi-rigid CT



Benefits

- Static applications
- Frequency range up to 40GHz
- Easy to form, strip and solder
- Space and time saving installation

Phase variation vs. temperature

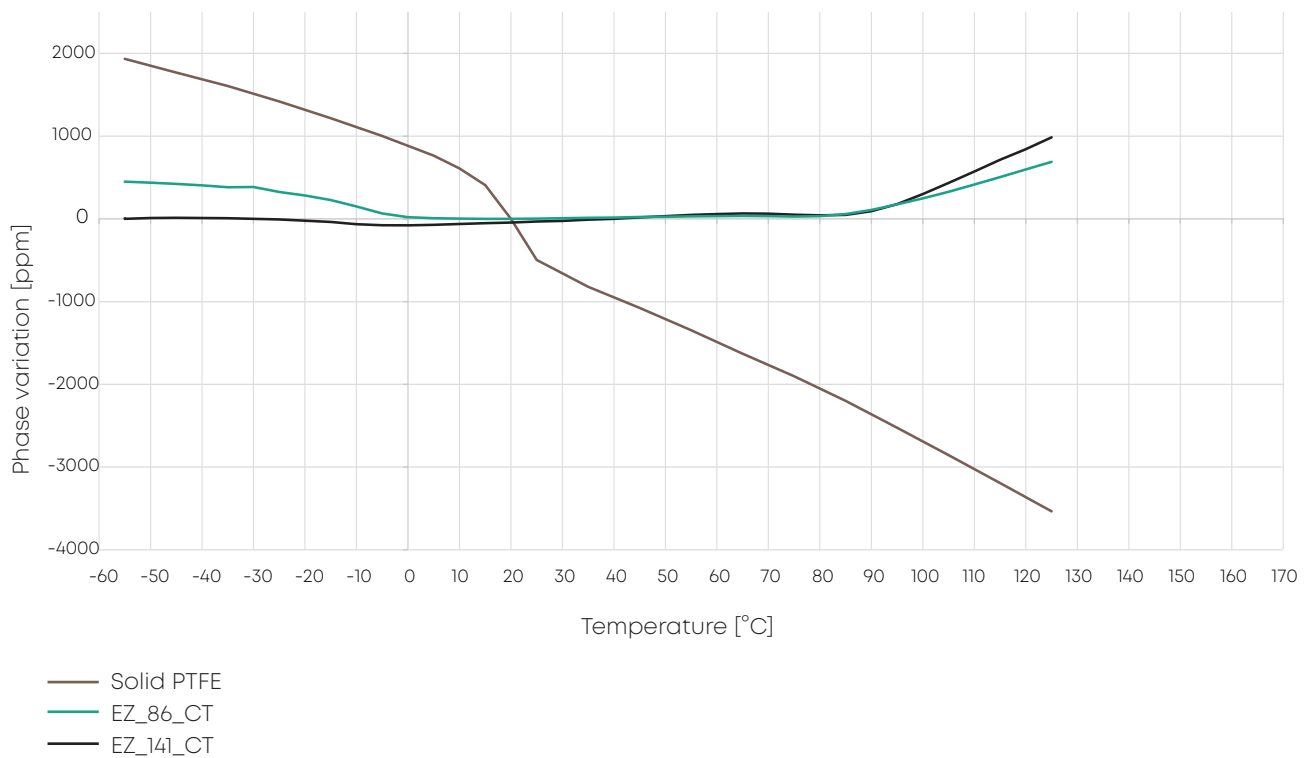

Product overview

Description	Frequency range	Insertion loss @18GHz	Outer diameter	Connectors
EZ_86_CT	40 GHz	3.18 dB/m	2.2 mm	SK, SMA, MMPX
EZ_141_CT	33 GHz	1.8 dB/m	3.58 mm	SK, SMA

Semi-rigid CT – graphs

Attenuation (nominal values at +25 °C ambient temperature)

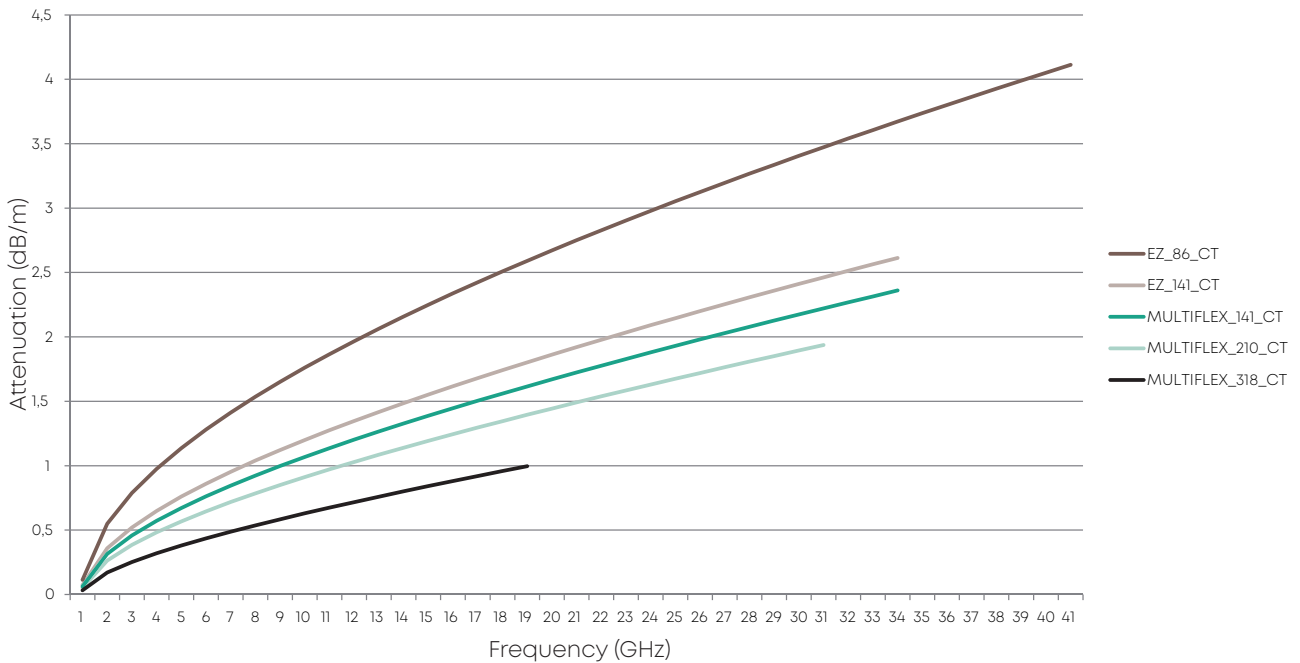

Power handling (maximum values at 25 °C ambient temperature and sea level)

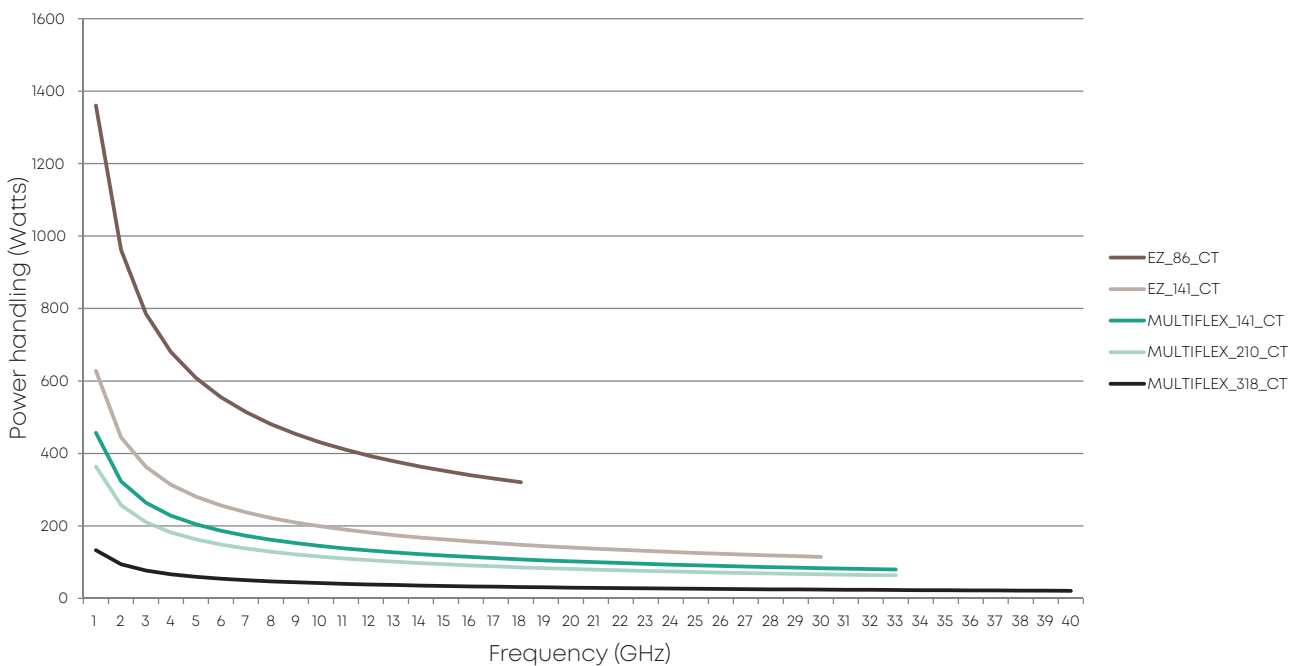

Multiflex CT



Benefits

- Flexible applications
- Frequency range up to 33 GHz
- Low loss
- Low weight

Phase variation vs. temperature

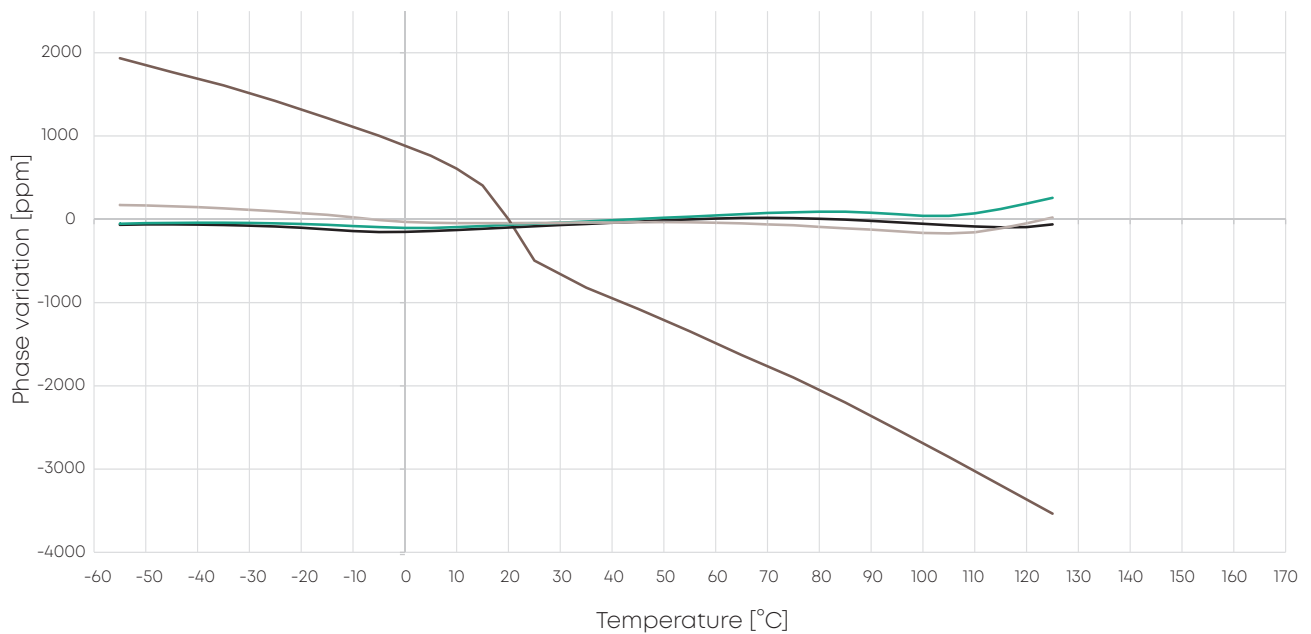

- Solid PTFE
- MF_318_CT
- MF_210_CT
- MF_141_CT

Product overview

Description	Frequency range	Insertion loss @18GHz	Outer diameter	Connectors
Multiflex_141_CT	33GHz	1.6 dB/m	4.2 mm	SK, SMA, BMA
Multiflex_210_CT	30GHz	1.4 dB/m	5.0 mm	SK, SMA, TNC
Multiflex_318_CT	18GHz	0.99 dB/m	7.5 mm	N, TNC

Multiflex CT – graphs

Attenuation (nominal values at +25 °C ambient temperature)

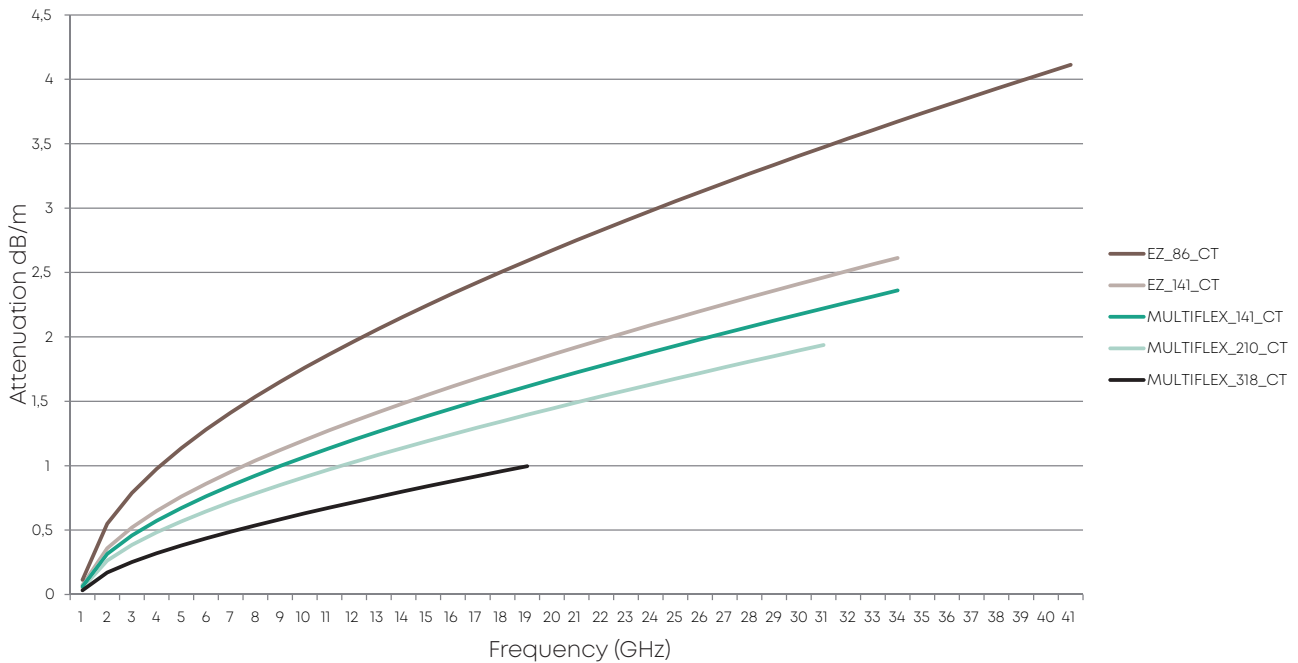

Power handling (maximum values at 25 °C ambient temperature and sea level)

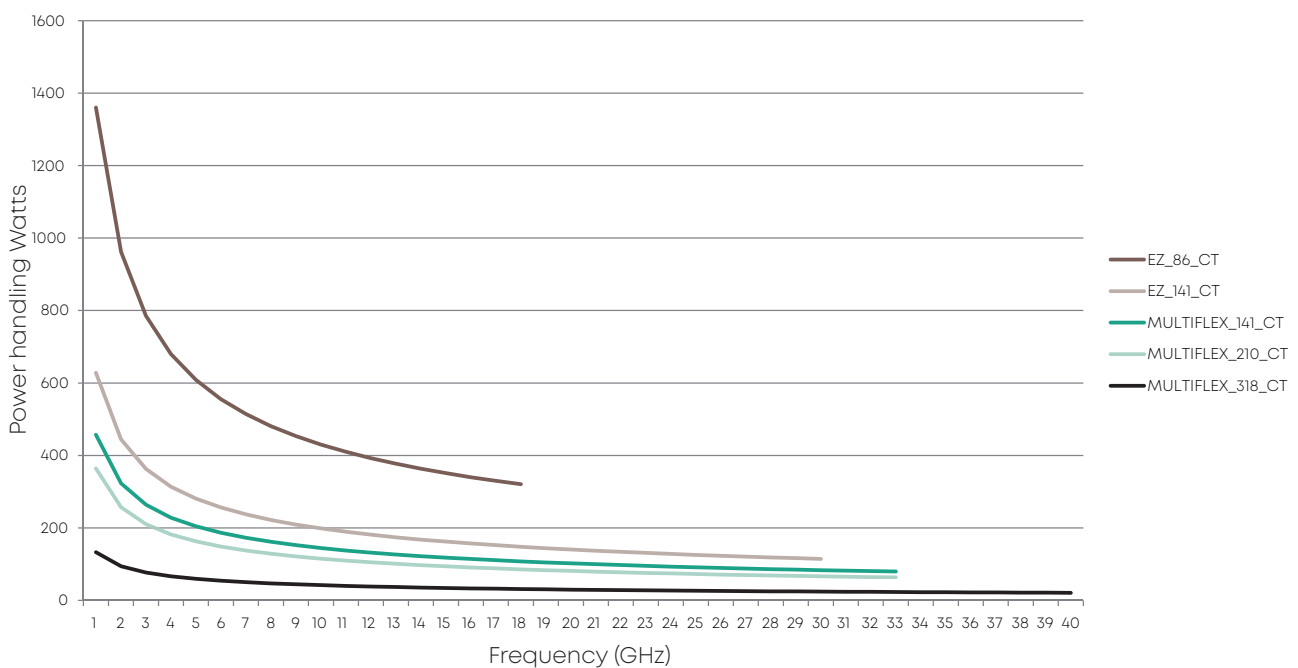

NANO BEND™

What is it? NANO BEND™ is a new and flexible, high-frequency coaxial cable assembly that is designed for use in low profile, internal, point-to-point interconnections between RF modules within communications systems. As the newest entrant found in the MINIBEND™ family of standard flexible cables, NANO BEND brings the same capabilities you depend on, but now in the smallest diameter available.



Product features

- Impedance 50 Ω
- Applicable up to 110 GHz
- Stock delivery on standard lengths
- Connections available that are found nowhere else in our current product offerings, including: Size 12 SMPM, Size 16 SMPS, Nanominiature Connections (pictured at right), VITA 67.1/2 SMPM, VITA 67.3 SMPM and SMPS, and more

Available Cable Connectors

Compatible connectors (other connectors may be made available upon request)

HUBER+SUHNER®-designed Nanominiature Connections, both Plug and Jack
SMA and SMA Bulkhead
SMPM
SMP
SK
Size 12 SMPM
Size 16 SMPS
HUBER+SUHNER-designed and TE®-compatible NANO RF Connections, both Plug and Jack
VITA 67.1/2 and VITA 67.3 SMPM Connector
VITA 67.3 SMPS Connector

Construction

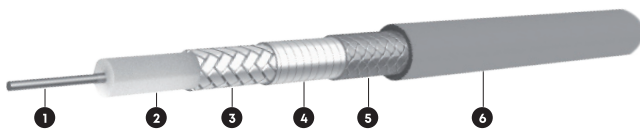

Cable	Inner Conductor	Dielectric	Outer Conductor	Barrier	Outer Braid	Jacket	Outer Diameter
	1	2	3	4	5	6	
32061SE	CuAg (SPC) Wire	Extruded PTFE	CuAg (SPC) flat wire braid	Aluminum / Polyimide Tape	Stainless Steel Braid	FEP	1.6 mm

Cable	Operating Frequency	Velocity (nominal)	Weight (nominal)	Static Min. Bend Radius	Impedance	Temp. Range
	GHz	%	g/m	mm	Ω	°C
32061SE	110	70.3	14.9	5.08	50	-55 to +200

NANOBEND™

Attenuation (dB/m) vs Frequency (GHz) of 32061SE

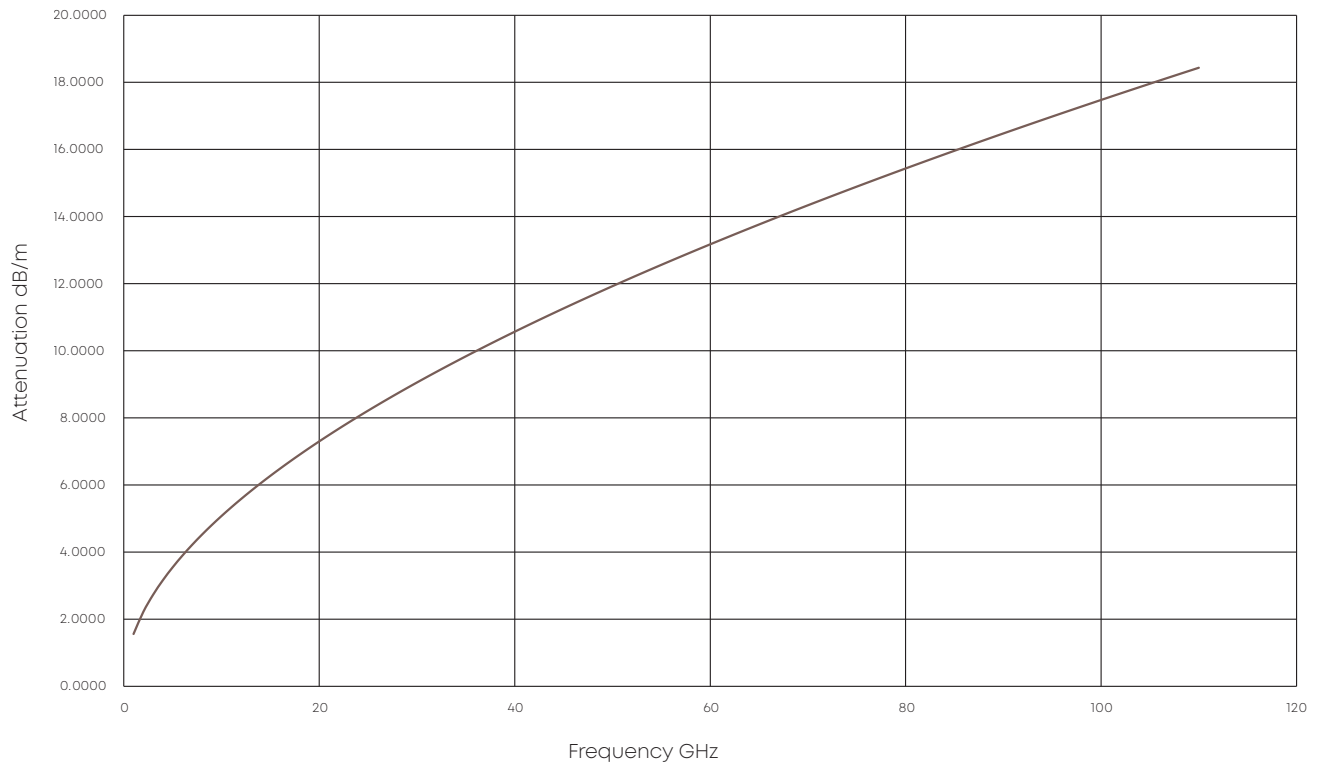

Space flight connectors

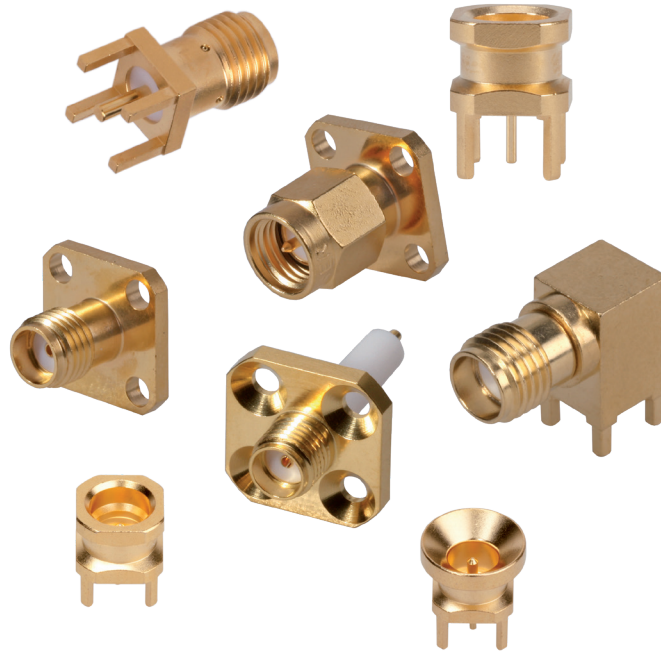

Our space flight-qualified connector portfolio has been designed for use within the most unique, robust and challenging applications. Our wide range of state-of-the-art connector interfaces, panel mount geometries, printed circuit boards (PCB) launch profiles, and customized solutions continue to drive significant growth in a highly specialized and dynamic technical sphere. Material selection of all HUBER+SUHNER space flight connectors meets and exceeds the requirements of MIL-PRF-39012.

Innovative solutions, such as the SMPM-T connector interface, continue to bolster HUBER+SUHNER's commitment to serving our space flight customers.

Features

- State-of-the-art space flight connectors
- Extensive flight heritage
- SMPM-T, the smallest threaded open source connector
- Solutions up to 65 GHz
- Space qualification heritage according to MIL standards
- Superior customer service

Benefits

- Unique and robust solutions
- One-stop-shop for space flight solutions
- Future-proof solutions

MIL-STD-348 compliant connectors

SMP, SMP-SL, SMPM and SMPM-T connectors are MIL-STD-348 compliant interfaces.

SMP-SL and SMPM-T are unique and innovative lockable versions which guarantee unprecedented electrical and mechanical performance even under extreme Aerospace conditions.



Power Sub-Miniature «PSM»

The PSM (Power Sub Miniature) interface meets the increasing demand for cost effective, low weight and power sensitive Aerospace applications. The PSM connector system enables customers to maximize connector density and minimize overall system weight.

- Space qualified per MIL-PRF-39012 and ESCC 3402



Space flight connector portfolio

The HUBER+SUHNER space flight connector portfolio has an extensive heritage, spanning more than two decades. The portfolio includes panel-receptacle connectors, Printed Circuit Boards (PCB's) and bulk-head cable connectors, which covers most space flight applications. Also hermetically sealed connectors are available. All designs, materials and processes comply with ECSS and NASA requirements.



Customized connectors/design capabilities

HUBER+SUHNER provides customized space flight connector solutions for applications that are not available in the space flight connector portfolio. Adaptations and new configurations can be developed and produced according to the relevant space flight requirements. Utilizing our world-class, on-site testing facilities, we are also able to perform verification tests, lot acceptance tests and qualification campaigns to meet verification and regulatory requirements of customized products.



SMP

Description

HUBER+SUHNER Astrolab SMP connectors provide a robust, proven and fully compatible plug-in solution for applications up to 40 GHz. HUBER+SUHNER Astrolab SMP connectors have been MIL-SPEC qualified for defence and space flight hardware. The design of the interface and materials treating provide true compatibility as well as guaranteed mechanical performance over the mating life of the connector with all MIL-STD-348 SMP connectors in the market.

Compatibility

50 Ω SMP connectors are intermateable without restrictions.

Interface dimensions (mm/inches)

SMP female

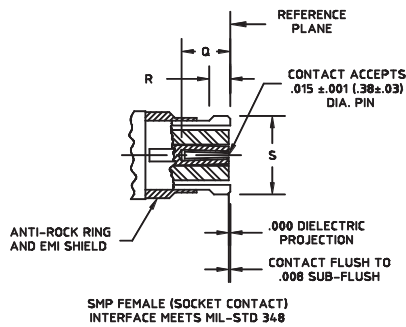

SMP male, full detent

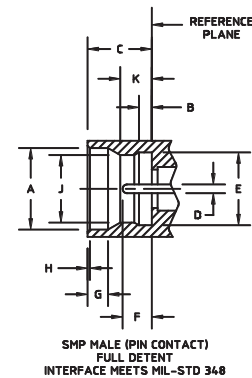

SMP male, limited detent

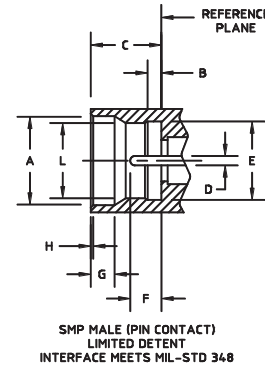

SMP male, smooth bore

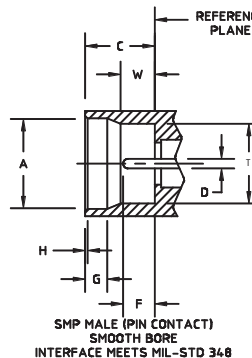

SMP male, catchers mitt

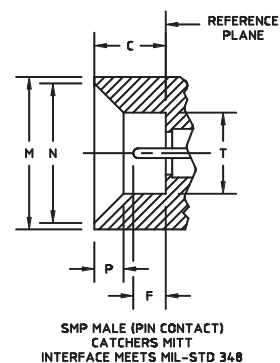

	min.	max.
A	3.53/0.139	3.68/0.145
B	0.521/0.0205	0.597/0.0235
C	2.74/0.108	2.84/0.112
D	0.36/0.014	0.41/0.016
E	3.15/0.124	3.20/0.126
F	1.14/0.045	1.40/0.055
G	0.084/0.033	0.94/0.037
H	0.08/0.003	0.20/0.008
J	2.90/0.114	3.00/0.118
K	1.30/0.051	1.45/0.057
L	3.00/0.118	3.10/0.122
M	5.84/0.230	6.10/0.240
N	5.33/0.210	5.59/0.220
P	1.09/0.043	1.19/0.047
Q	1.77/0.070	-
R	0.63/0.025	0.88/0.035 (cabled connector)
	0.45/0.018	0.63/0.025 (uncabled connector)
S	-	3.43/0.135
T	3.12/0.123	3.22/0.127
W	1.49/0.059	1.65/0.065

Interface dimensions conformable to the following standards:

USA: MIL-PRF-31031
SMP interface MIL-STD-348

SMP – technical data

Electrical data	Requirements
Impedance	50 Ω
Frequency range	DC to 40 GHz
Contact resistance	center conductor 6.0 milliohms max. outer conductor 2.0 milliohms max.
DWV	500 Vrms at sea level
Insulation resistance	5000 megaohms min.
Corona levels	190 Vrms at 70 000 ft
RF high potential	325 Vrms at 5 MHz
RF leakage	80 dB max. at 3 GHz 65 dB max. at 3 to 26.5 GHz
Magnetic permeability	< 2 μ
VSWR	Connector specific
Insertion loss	0.06 \sqrt{f} in GHz (non-hermetic connectors) 0.12 \sqrt{f} in GHz (hermetic connectors)

Mechanical data	Requirements
Center contact retention	1.5 lbs (6.672 N) min. (captivated designs)
Durability	100 cycles min. into a full detent shroud 500 cycles min. into a limited detent shroud 1000 cycles min. into a smooth bore shroud
Force to engage	SMP full detent – 15 lbs (66.723 N) max. SMP limited detent – 10 lbs (44.482 N) max. SMP smooth bore – 2 lbs (8.896 N) max.
Force to disengage	SMP full detent – 5 lbs (22.241 N) min. SMP limited detent – 2 lbs (8.896 N) min. SMP smooth bore – 0.5 lbs (2.224 N) min.
Radial misalignment	standard – \pm 0.25 mm/0.010 in. min. float mount – \pm 0.76 mm /0.030 in. min.
Axial misalignment	standard – 0.25 mm/0.010 in. min. float mount – 1.27 mm/0.050 in. min.

Environmental data	Requirements
Temperature range	-65 to +165 $^{\circ}$ C
Thermal shock	MIL-STD-202, method 107, condition B
Moisture resistance	MIL-STD-202, method 106
Corrosion	MIL-STD-202, method 101, condition B
Sine vibration	MIL-STD-202, method 204, 28 g peak
Random vibration	MIL-STD-202, method 214, condition K-I, 46.3 g
Shock	MIL-STD-202, method 213, 12 000 g peak

SMP – technical data

Material data		
Cable and shroud connectors	Material	Plating
Body	beryllium copper per ASTM B-196 or brass per QQ-B-626	SUCOPRO gold plate
	#303 SS per ASTM A-582	passivated per SAE-AMS-2700
Contact	beryllium copper per ASTM B-196	SUCOPRO gold plate
Dielectric	PTFE per ASTM D-1710, type I, grade 1 or Torlon™ per ASTM D-5204	–
Ferrule	brass per ASTM B-135	SUCOPRO gold plate
Hermetic shroud connectors	Material	Plating
Body and contact	Kovar® per ASTM F-15, class 1	gold plate per ASTM B-488, code A, type III over nickel plate per SAE-AMS-QQ-N-290, type 1
Dielectric	Corning 7070 glass or equivalent	–
Adaptors	Material	Plating
Body and nut	beryllium copper per ASTM B-196 or #303 SS per ASTM A-582	gold plate per ASTM B-488, code C, type II over nickel plate per SAE-AMS-QQ-N-290, type 1
Contact	beryllium copper per ASTM B-196	gold plate per ASTM B-488, code C, type II over nickel plate per SAE-AMS-QQ-N-290, type 1
Dielectric	PTFE per ASTM D-1710, type I, grade 1 and Ultem™ per ASTM D-5205	–

Performance listed is typical. Individual part configuration may vary. Contact HUBER+SUHNER Astrolab for more information and specifications by part number. Customer specific factors pertaining to recommended mounting patterns including transmission line topology, substrate thickness and material, board-stackup, operating frequency, etc. must be submitted to HUBER+SUHNER Astrolab for analysis prior to release of final performance levels and mounting configurations.

SMP – cable connectors

Straight cable jacks (female)

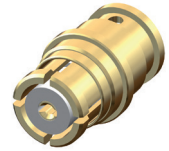
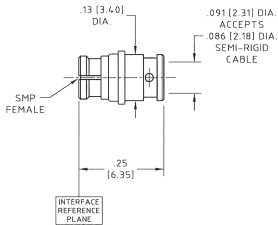

HUBER+SUHNER type	Item no.	Cable group (example)	Typ. return loss	Packaging
21_SMP-50-2-1/111_NE	80377838	Y3, Y16, Y11 (2.18 mm/0.086 in)	DC – 20 GHz: 29 dB 20 – 30 GHz: 27 dB 30 – 40 GHz: 20 dB	single

Right angle cable jack (female)

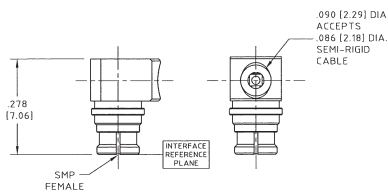

HUBER+SUHNER type	Item no.	Cable group (example)	Typ. return loss	Packaging
26_SMP-50-2-2/111_NE	80377839	Y3, Y16, Y11 (2.18 mm/0.086 in)	DC – 20 GHz: 25 dB 20 – 26.5 GHz: 20 dB 26.5 – 30 GHz: 15 dB 26.5 – 40 GHz: 10 dB	single

SMP – panel mount connectors

Straight bulkhead cable plugs (male)

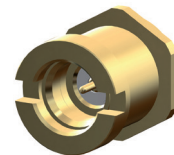
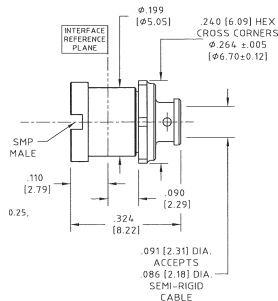

HUBER+SUHNER type	Item no.	Cable group (example)	Typ. return loss	Detent	Packaging
14_SMP-50-2-S2/119_NE	80377975	Y3, Y16, Y11 (2.18 mm/0.086 in)	DC – 20 GHz: 29 dB 20 – 30 GHz: 27 dB 30 – 40 GHz: 20 dB	smooth bore	single
14_SMP-50-2-L2/119_NE	80377974	Y3, Y16, Y11 (2.18 mm/0.086 in)	DC – 20 GHz: 29 dB 20 – 30 GHz: 27 dB 30 – 40 GHz: 20 dB	limited detent	single

Straight panel mount receptacle (male)

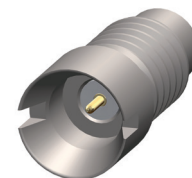
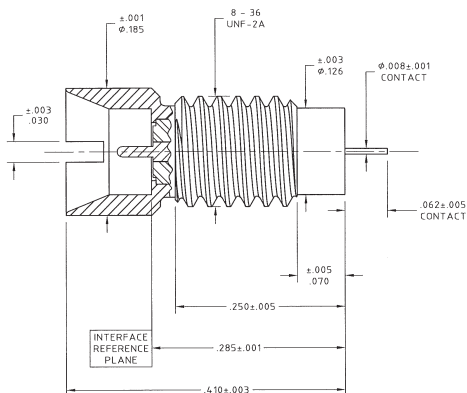

HUBER+SUHNER type	Item no.	Operating frequency	Detent	Pin length	Packaging
12_SMP-50-0-S1/119_NE	80378538	DC – 40 GHz	catchers mitt	0.062"/1.57 mm additional length on request	single

SMP – hermetic shrouds

Hermetically sealed, plugs (male)

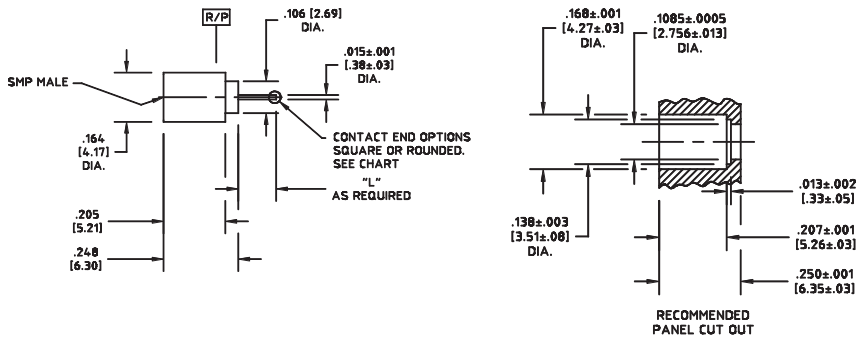

HUBER+SUHNER type	Item no.	"L"	End option
		mm/in	
29474H-1S	80367958	1.25/0.050 additional length on request	square

SMP – PCB mount connectors

Straight PCB plugs (male)

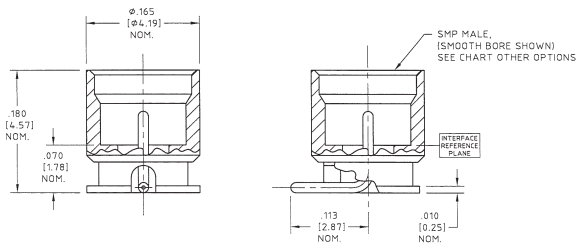

HUBER+SUHNER type	Item no.	Detent	Operating frequency	Return loss	Packaging
81_SMP-S50-0-L1/111_NE	80377946	limited detent	DC – 40GHz	depends on PCB stack-up, contact HUBER+SUHNER	single
81_SMP-S50-0-S1/111_NE	80377947	smooth bore	DC – 40GHz	depends on PCB stack-up, contact HUBER+SUHNER	single

Edge mount PCB plugs (male)

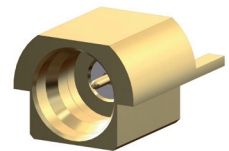
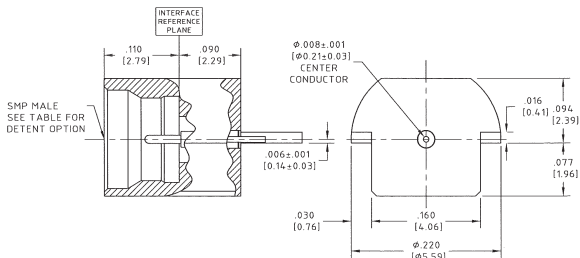

HUBER+SUHNER type	Item no.	Detent	Operating frequency	Return loss	Packaging
91_SMP-50-0-L1/111_NE	80377833	limited detent	DC – 40GHz	depends on PCB stack-up, contact HUBER+SUHNER	single
91_SMP-50-0-S1/111_NE	80377835	smooth bore	DC – 40GHz	depends on PCB stack-up, contact HUBER+SUHNER	single

SMP – adaptors

Adaptor SMP jack – 2.9 mm jack (female/female)

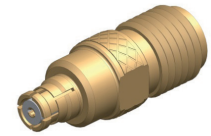
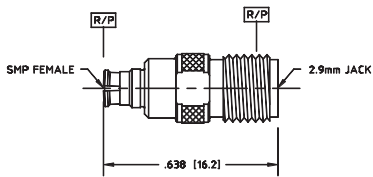

HUBER+SUHNER type	Item no.	Packaging
29487-3	80318039	single

Adaptor SMP jack – 2.9 mm plug (female/male)

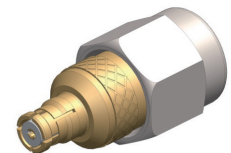
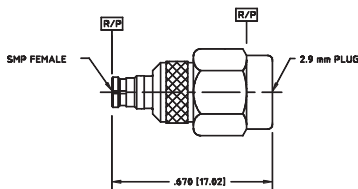

HUBER+SUHNER type	Item no.	Packaging
29487-4	80363059	single

Adaptor SMP plug – 2.9 mm plug (male/male)

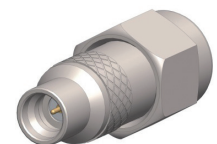
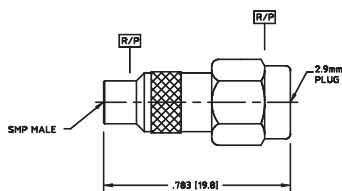

HUBER+SUHNER type	Item no.	Packaging	Detent
29487-1	80318037	single	full

Adaptor/bullet jack/jack (female/female)

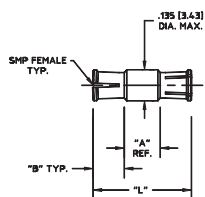

HUBER+SUHNER type	Item no.	Packaging	"A"	Adaptor length X	"B"
31_SMP-50-0-5/111_NE	80377837	single	0.075"/1.91 mm	0.345"/8.76 mm	0.135"/3.43 mm
31_SMP-50-0-6/111_NE	80377836	single	0.190"/12.45 mm	0.760"/19.30 mm	0.135"/3.43 mm

SMMPM

Description

HUBER+SUHNER Astrolab SMMPM connectors offer unrivaled miniaturisation and performance for RF applications up to 65 GHz. HUBER+SUHNER Astrolab SMMPM connectors are MIL-SPEC qualified for defence and space flight applications. Along with the unique bend-to-the-end microbend style cable connectors,

HUBER+SUHNER Astrolab offers a large portfolio of different PCB mount SMMPM connectors that have been designed with optimised PCB trace launch geometries to offer a complete interconnect design solution from "wire-to-trace".

Compatibility

50 Ω SMMPM connectors are intermateable without restrictions.

Interface dimensions (mm/inches)

SMMPM female (socket contact)

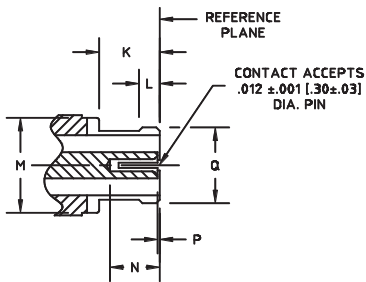

SMMPM FEMALE (SOCKET CONTACT)
INTERFACE MEETS MIL-STD-348

SMMPM male (pin contact), smooth bore

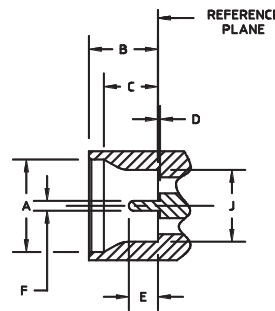

SMMPM MALE (PIN CONTACT)
SMOOTH BORE
INTERFACE MEETS MIL-STD-348

SMMPM male (pin contact), full detent

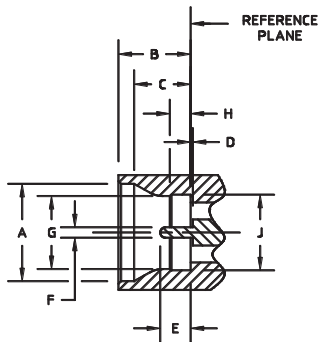

SMMPM MALE (PIN CONTACT)
FULL DETENT
INTERFACE MEETS MIL-STD-348

	min.	max.		min.	max.
A	2.82/0.111	2.92/0.115	J	2.18/0.086	2.24/0.088
B	2.08/0.082	2.13/0.084	K	1.73/0.068	–
C	1.57/0.062	1.83/0.072	L	–	0.58/0.023
D	0.00/0.000	–	M	–	2.79/0.110
E	0.76/0.030	1.14/0.045	N	1.27/0.050	–
F	0.28/0.011	0.33/0.013	P	0.00/0.000	0.20/0.008
G	2.11/0.083	2.16/0.085	Q	–	2.41/0.095
H	0.53/0.021	0.58/0.023			

Interface dimensions conformable to the following standards:

USA: MIL-PRF-31031
SMMPM interface MIL-STD-348

SMPM – technical data

Electrical data	Requirements
Impedance	50 Ω
Frequency range	DC to 65 GHz
Contact resistance	center conductor 6.0 milliohms max. outer conductor 2.0 milliohms max.
DWV	335 Vrms at sea level
Insulation resistance	5000 megaohms min.
Corona levels	125 Vrms at 70 000 ft
RF high potential	200 Vrms at 5 MHz
RF leakage	80 dB max. at 3 GHz 65 dB max. at 3 to 26.5 GHz
Magnetic permeability	< 2 μ
VSWR	1.1:1 to 26.5 GHz 1.3:1 to 65 GHz
Insertion loss	0.05 + 0.04 \sqrt{f} in GHz (non-hermetic connectors) 0.12 \sqrt{f} in GHz (hermetic connectors)

Mechanical data	Requirements
Center contact retention	1.5 lbs (6.672 N) min. (captivated designs)
Durability	100 cycles min. into a full detent shroud 1000 cycles min. into a smooth bore shroud
Force to engage	SMPM full detent – 3.5 lbs (15.569 N) typical SMPM smooth bore – 1.5 lbs (6.672 N) typical
Force to disengage	SMPM full detent – 5 lbs (22.241 N) typical SMPM smooth bore – 1.5 lbs (6.672 N) typical

Environmental data	Requirements
Temperature range	-65 to +165 °C
Thermal shock	MIL-STD-202, method 107, condition B
Moisture resistance	MIL-STD-202, method 106
Corrosion	MIL-STD-202, method 101, condition B
Sine vibration	MIL-STD-202, method 204, 28 g peak
Random vibration	MIL-STD-202, method 214, condition K-1, 46.3 g
Shock	MIL-STD-202, method 213, 12 000 g peak

SMPM – technical data

Material data		
Cable and shroud connectors	Material	Plating
Body and contact	beryllium copper per ASTM B-196	gold plate per ASTM B-488, code C, type II over nickel plate per SAE-AMS-QQ-N-290, type 1
Dielectric	PTFE per ASTM D-1710, type I, grade 1 or Torlon™ per ASTM D-5204	–
Shroud	#303 SS per ASTM A-582	passivated per SAE-AMS-2700
Hermetic shroud connectors	Material	Plating
Body and contact	Kovar® per ASTM F-15, class 1	gold plate per ASTM B-488, code A, type III over nickel plate per SAE-AMS-QQ-N-290, type 1
Dielectric	Corning 7070 glass or equivalent	–
Adaptors	Material	Plating
Body and nut	#303 SS per ASTM A-582	gold plate per ASTM B-488, code C, type II over nickel plate per SAE-AMS-QQ-N-290, type 1
Contact	beryllium copper per ASTM B-196	gold plate per ASTM B-488, code C, type II over nickel plate per SAE-AMS-QQ-N-290, type 1
Dielectric	PTFE per ASTM D-1710, type I, grade 1 and Ultem™ per ASTM D-5205	–

Performance listed is typical. Individual part configuration may vary. Contact HUBER+SUHNER Astrolab for more information and specifications by part number. Customer specific factors pertaining to recommended mounting patterns including transmission line topology, substrate thickness and material, board-stackup, operating frequency, etc. must be submitted to HUBER+SUHNER Astrolab for analysis prior to release of final performance levels and mounting configurations.

SMPM – hermetic shrouds

Hermetically sealed, plugs (male)

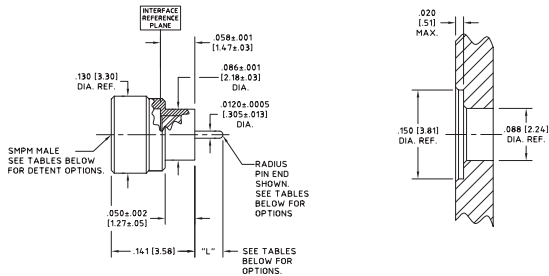

HUBER+SUHNER type	Item no.	"L"	End option	Detent
		mm/in		
29972H1-2-030S	80376464	0.762/0.030	square	full
29972H1-2-050S	80376465	1.270/0.050	square	full
29972H1-2-060S	80395460	1.524/0.060	square	full
29972H1-2-070S	80395461	1.778/0.070	square	full
29972H1-2-090S	80395462	2.286/0.090	square	full
29972H1-4-030S	80395463	0.762/0.030	square	smooth bore
29972H1-4-050S	80395464	1.270/0.050	square	smooth bore
29972H1-4-060S	80395465	1.524/0.060	square	smooth bore
29972H1-4-070S	80395466	1.778/0.070	square	smooth bore
29972H1-4-090S	80395467	2.286/0.090	square	smooth bore

SMPM – PCB mount connectors

Straight PCB plugs (male)

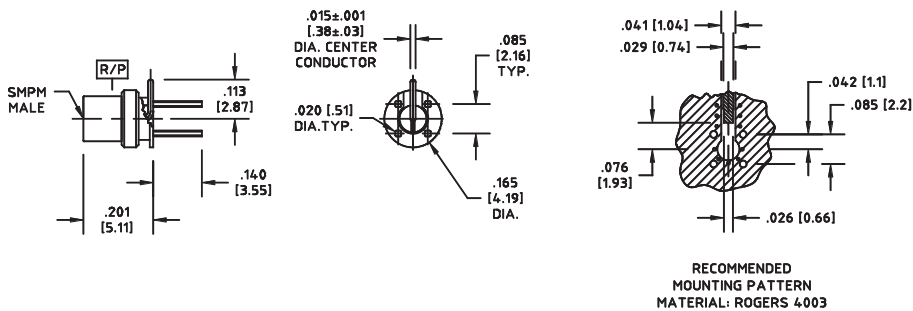

HUBER+SUHNER type	Item no.	Detent
29972S1-2-001	80367473	full
29972S1-4-001	80367474	smooth bore

Straight PCB plugs (male)

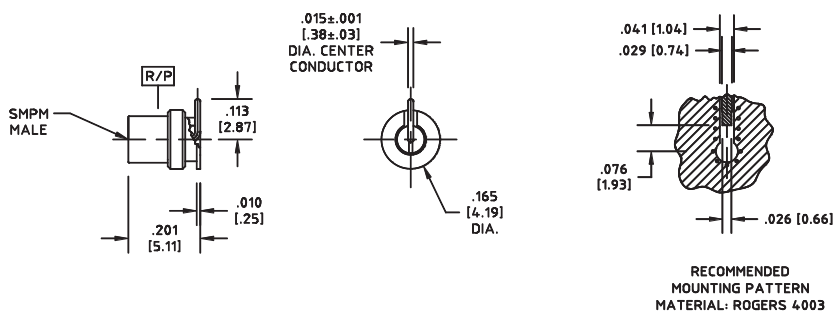

HUBER+SUHNER type	Item no.	Detent
29972SM-2-001	80367475	full
29972SM-4-001	80367476	smooth bore

Straight PCB plugs (male)

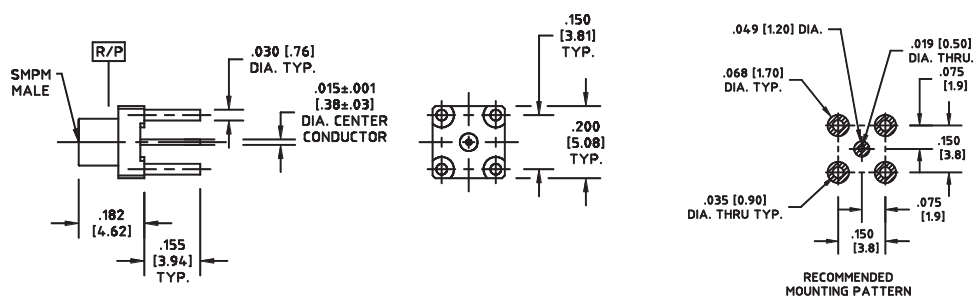

HUBER+SUHNER type	Item no.	Detent
29972T1-2-155	80395469	full
29972T1-4-155	80395470	smooth bore

SMPM – edge mount connectors

Edge mount PCB plugs (male)

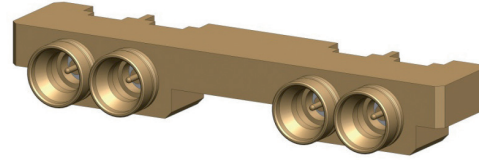
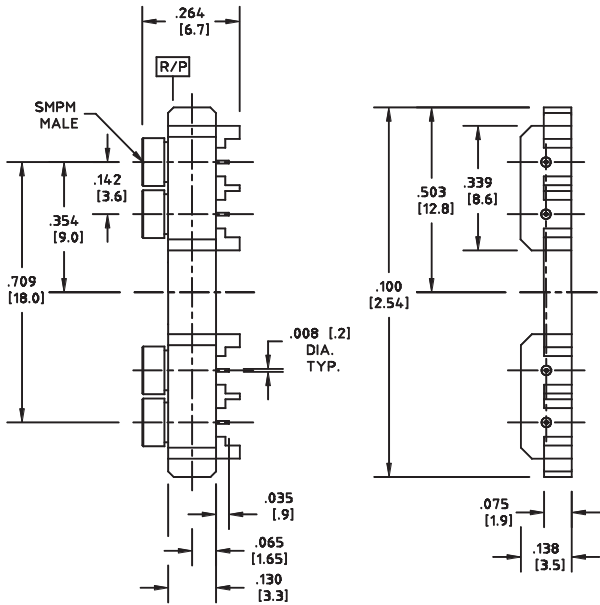

HUBER+SUHNER type	Item no.	Detent
29976CB7-2-4	80374382	full
29976CB7-4-4	80395468	smooth bore

Edge mount PCB plugs (male)

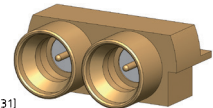
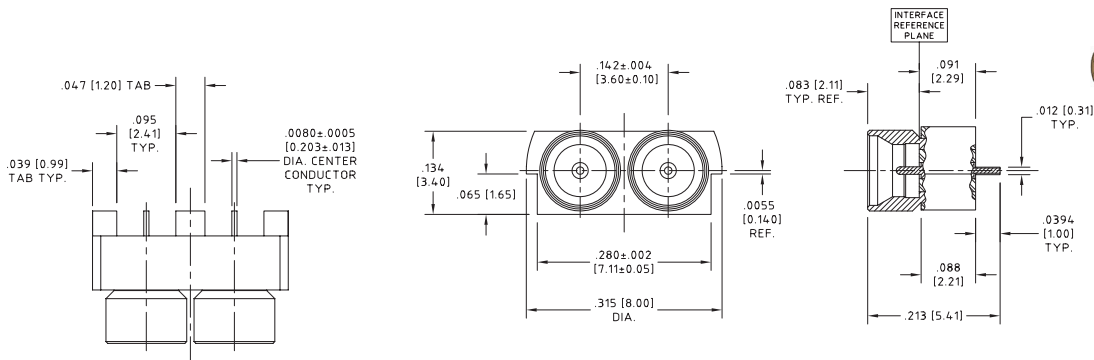

HUBER+SUHNER type	Item no.	Detent
29972CB2-2-002	80376772	full
29972CB2-4-002	80376773	smooth bore

SMPM – edge mount connectors

Edge mount PCB plugs (male)

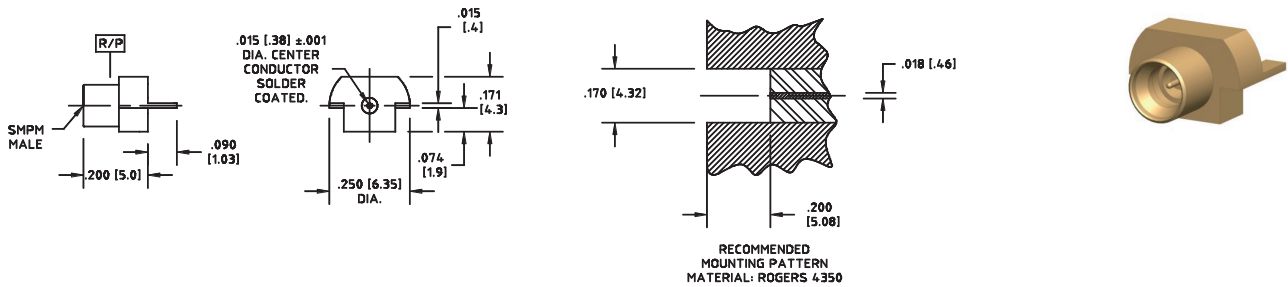

HUBER+SUHNER type	Item no.	Detent
29972BM-2-002	80395471	full
29972BM-4-002	80362691	smooth bore

Edge mount PCB plugs (male)

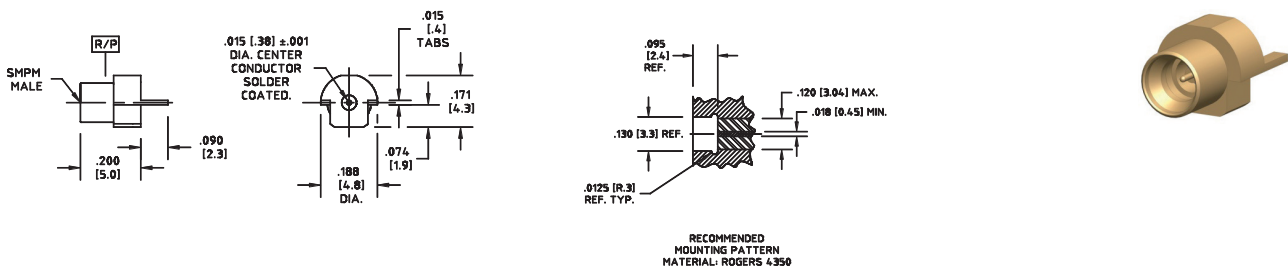

HUBER+SUHNER type	Item no.	Detent
29972BM-2-004	80395472	full
29972BM-4-004	80395473	smooth bore

Edge mount PCB plugs (male)

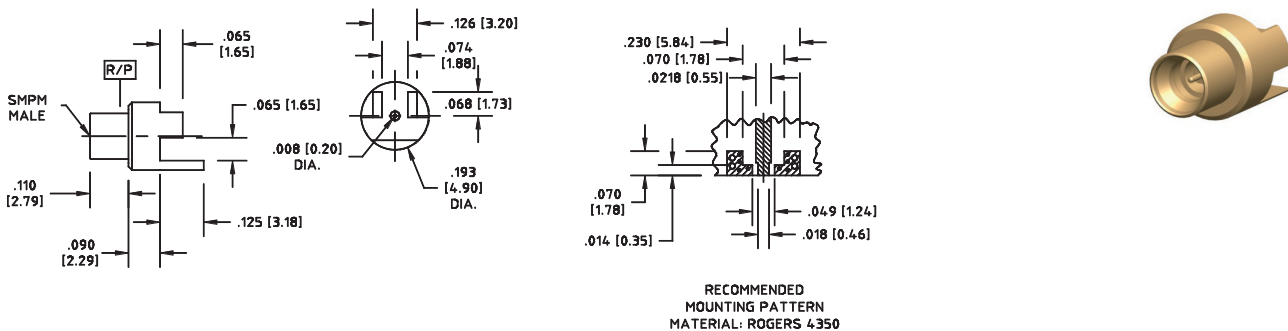

HUBER+SUHNER type	Item no.	Detent
29972EM-2-001	80395474	full
29972EM-4-001	80377148	smooth bore

SMPM – adaptor

Adaptor jack/jack (female/female)

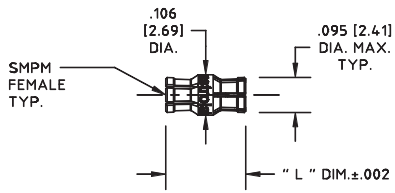

HUBER+SUHNER type	Item no.	Packaging	Adaptor length L
			mm/in
29981-A2F1	80372056	single	5.33/0.210
29981-A2F2	80363712	single	12.7/0.500
29981-A2F3	80376811	single	6.45/0.254

Note: Adaptors to other interfaces can be found in the section SMPM-T (page 112).
 The SMPM-T plug (male) to SK adaptors can also be used to connect SMPM.

SMPM-T

Description

The SMPM-T is the smallest threaded open source connector on the market. Its unique and innovative combination of a MIL-STD-348 SMPM female interface connector together with a retractable threaded nut provides an integrated solution offering unprecedented electrical and mechanical performance. The SMPM-T handles high density requirements with a connector centerline-to-centerline spacing of just 5 mm (0.20 in) while offering unmatched electrical stability at frequencies up to 65 GHz in even the harshest operating environments.

The SMPM-T connector is available along with HUBER+SUHNER Astrolab's industry driving microbend "bend-to-the-end" technology that is already qualified for any aerospace application. The SMPM-T connector complies with the hi-rel material restrictions of NASA while still offering full compliance with RoHS and REACH legislation in the commercial market.

Compatibility

50 Ω SMPM-T connectors are intermateable without restrictions.

Interface dimensions (mm/inches)

SMPM-T female (socket contact)

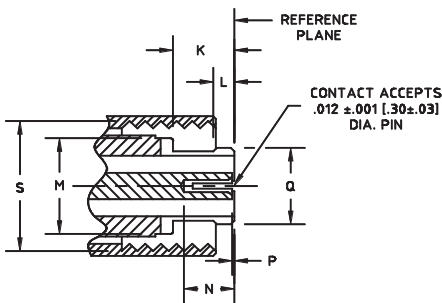

SMPM-T FEMALE (SOCKET CONTACT)
INTERFACE MEETS MIL-STD-348

SMPM-T male (pin contact), smooth bore

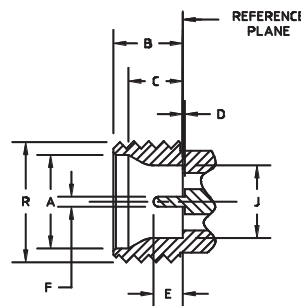

SMPM-T MALE (PIN CONTACT)
SMOOTH BORE
INTERFACE MEETS MIL-STD-348

SMPM-T male (pin contact), full detent

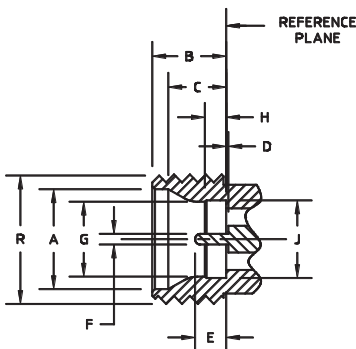

SMPM-T MALE (PIN CONTACT)
FULL DETENT
INTERFACE MEETS MIL-STD-348

	min.	max.		min.	max.
A	2.82 / 0.111	2.92 / 0.115	K	1.73 / 0.068	–
B	2.08 / 0.082	2.13 / 0.084	L	–	0.58 / 0.023
C	1.57 / 0.062	1.83 / 0.072	M	–	2.79 / 0.110
D	0.00 / 0.000	–	N	1.27 / 0.050	–
E	0.76 / 0.030	1.14 / 0.045	P	0.00 / 0.000	0.20 / 0.008
F	0.28 / 0.011	0.33 / 0.013	Q	–	2.41 / 0.095
G	2.11 / 0.083	2.16 / 0.085	R	–	3.66 / 0.145
H	0.53 / 0.021	0.58 / 0.023	S	3.30 / 0.130	–
J	2.18 / 0.086	2.24 / 0.088			

Interface dimensions conformable to the standards:

USA: MIL-PRF-31031
SMPM interface MIL-STD-348

SMPM-T – technical data

Electrical data	Requirements
Impedance	50 Ω
Frequency range	DC to 65 GHz
Contact resistance	center conductor 6.0 milliohms max. outer conductor 2.0 milliohms max.
DWV	335 Vrms at sea level
Insulation resistance	5000 megaohms min.
Corona levels	125 Vrms at 70 000 ft
RF high potential	200 Vrms at 5 MHz
RF leakage	-80 dB max. at 3 GHz -65 dB max. at 3 to 26.5 GHz
Magnetic permeability	< 2 μ
VSWR	1.1:1 to 26.5 GHz 1.3:1 to 65 GHz
Insertion loss	0.05 + 0.04 \sqrt{f} in GHz (non-hermetic connectors) 0.12 \sqrt{f} in GHz (hermetic connectors)

Mechanical data	Requirements
Center contact retention	1.5 lbs (0.68 kg) min. (captivated designs)
Durability	100 cycles min. into a full detent shroud 1000 cycles min. into a smooth bore shroud
Force to engage	SMPM full detent – 3.5 lbs (1.59 kg) typical SMPM smooth bore – 1.5 lbs (0.68 kg) typical
Force to disengage	SMPM full detent – 5 lbs (2.27 kg) typical SMPM smooth bore – 1.5 lbs (0.68 kg) typical
Mating torque	22 \pm 2 in-oz (0.016 \pm 0.001 m-kg)

Environmental data	Requirements
Temperature range	-65 to +165 $^{\circ}$ C
Thermal shock	MIL-STD-202, method 107, condition B
Moisture resistance	MIL-STD-202, method 106
Corrosion	MIL-STD-202, method 101, condition B
Sine vibration	MIL-STD-202, method 204, 28g peak
Random vibration	MIL-STD-202, method 214, condition K-I, 46.3 grms
Shock	MIL-STD-202, method 213, 12 000 g peak

SMPM-T – technical data

Material data		
Cable and shroud connectors	Material	Plating
Body and contact	beryllium copper per ASTM B-196	gold plate per ASTM B-488, code C, type II over nickel plate per SAE-AMS-QQ-N-290, type 1
Dielectric	PTFE per ASTM D-1710, type I, grade 1, Torlon™ per ASTM D-5204 or Ultem™ per ASTM D-5205	–
Hermetic shroud connectors	Material	Plating
Body and contact	Kovar® per ASTM F-15, class 1	gold plate per ASTM B-488, code A, type III over nickel plate per SAE-AMS-QQ-N-290, type 1
Dielectric	Corning 7070 glass or equivalent	–
Adaptors	Material	Planting
Body and nut	#303 SS per ASTM A-582	gold plate per ASTM B-488, code C, type II over nickel plate per SAE-AMS-QQ-N-290, type 1
Contact	beryllium copper per ASTM B-196	gold plate per ASTM B-488, code C, type II over nickel plate per SAE-AMS-QQ-N-290, type 1
Dielectric	PTFE per ASTM D-1710, type I, grade 1 and Ultem™ per ASTM D-5205	–

Performance listed is typical. Individual part configuration may vary. Contact HUBER+SUHNER Astrolab for more information and specifications by part number. Customer specific factors pertaining to recommended mounting patterns including transmission line topology, substrate thickness and material, board-stackup, operating frequency, etc. must be submitted to HUBER+SUHNER Astrolab for analysis prior to release of final performance levels and mounting configurations.

SMPM-T – cable connector

Straight cable jacks (female)

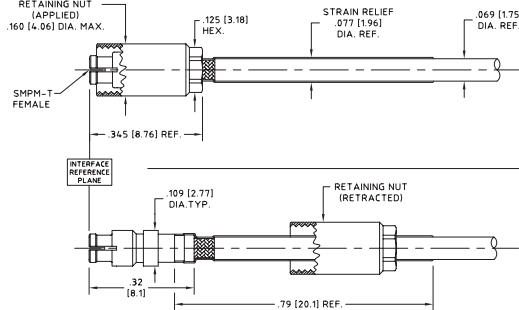
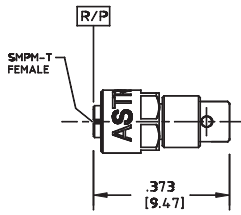

Fig. 1

Fig. 2

HUBER+SUHNER type	Item no.	Cable group (example)	Packaging	Cable dia. mm/in	Fig.
29971T-096FLEX	80366348	Y3, Y16, Y11 (2.18 mm/0.086 in)	single	2.43/0.096	1
29971T-MF53	80376818	Y3, Y16, Y11 (2.18 mm/0.086 in)	single	1.96/0.077	2

SMPM-T – hermetic shrouds

Hermetically sealed, plugs (male)

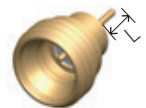
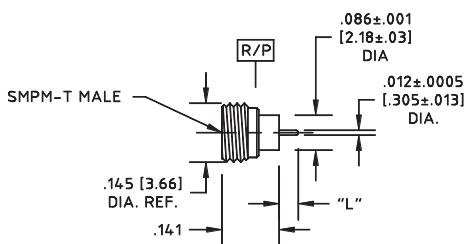

HUBER+SUHNER type	Item no.	Contact length "L" mm/in	End option	Detent
29976H1-2-060S	80362701	1.52/0.06	full	square
29976H1-2-090S	80362703	2.28/0.09	full	square
29976H1-4-060S	80362705	1.52/0.06	smooth bore	square
29976H1-4-090S	80362707	2.28/0.09	smooth bore	square

SMPM-T – panel mount connectors

Straight bulkhead receptacles, plug (male)

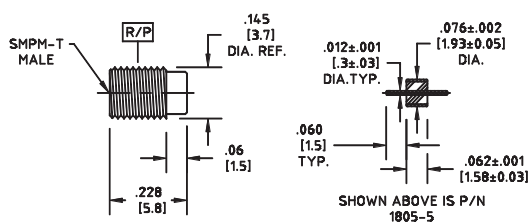

Bead as shown on picture sold separately.

HUBER+SUHNER type	Item no.	Detent
29976TSP-2-005	80370422	full
29976TSP-4-005	80374421	smooth bore

SMPM-T – PCB mount connectors

Straight PCB plugs (male)

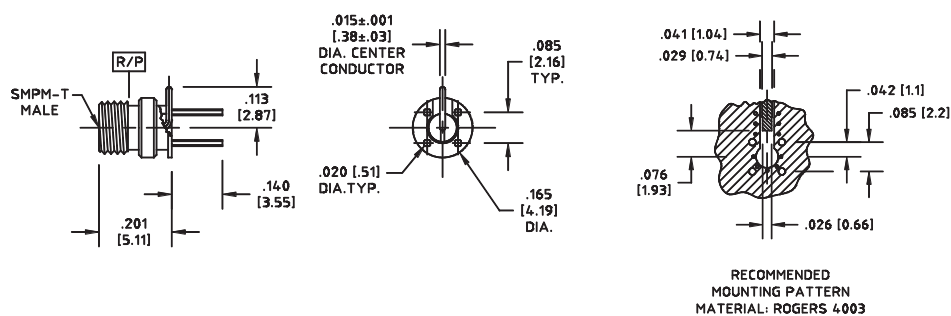

HUBER+SUHNER type	Item no.	Detent
29976S1-2-140	80362694	full
29976S1-4-140	80362695	smooth bore

SMPM-T – PCB mount connectors

Right angle PCB plugs (male)

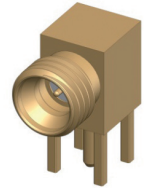
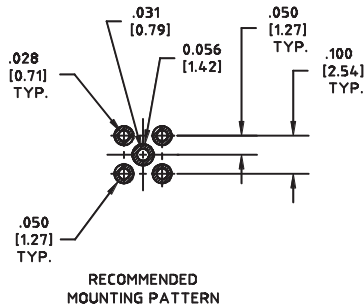
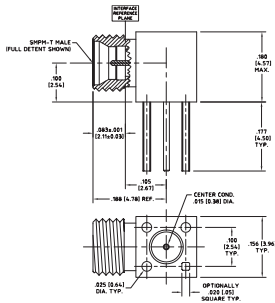

HUBER+SUHNER type	Item no.	Detent
29976RA-2-001	80374263	full
29976RA-4-001	80374264	smooth bore

Straight PCB plugs (male)

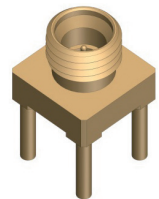
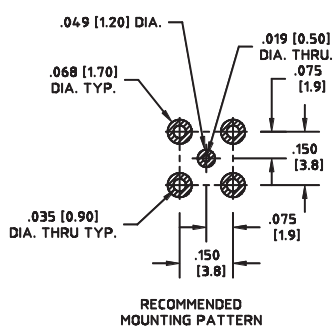
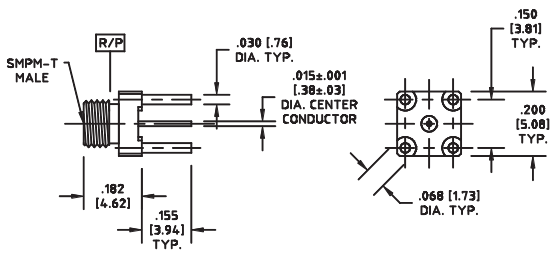

HUBER+SUHNER type	Item no.	Detent
29976T1-2-155	80366706	full
29976T1-4-155	80370524	smooth bore

Straight PCB plugs (male)

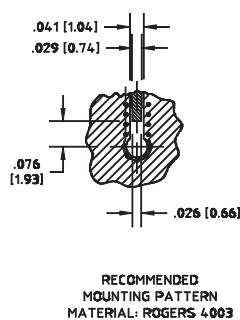
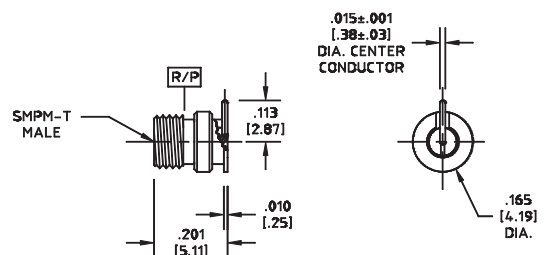

HUBER+SUHNER type	Item no.	Detent
29976SM-2-001	80362696	full
29976SM-4-001	80362697	smooth bore

SMPM-T – PCB mount connectors

Straight PCB plugs (male)/reverse mount

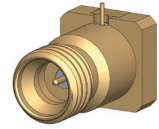
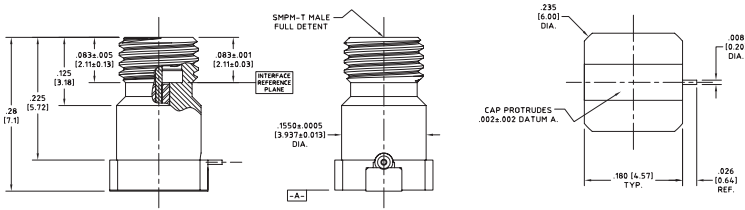

HUBER+SUHNER type	Item no.	Detent
29976TRM-2-001	80374144	full
29976TRM-4-001	80395475	smooth bore

Right angle PCB plugs (male)

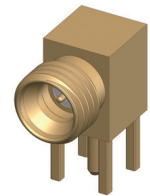
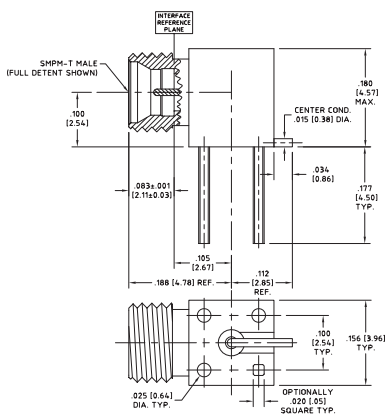

HUBER+SUHNER type	Item no.	Detent
29976RA-2-003	80376679	full
29976RA-4-003	80376680	smooth bore

SMPM-T – edge mount connectors

Edge mount PCB plugs (male)

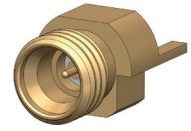
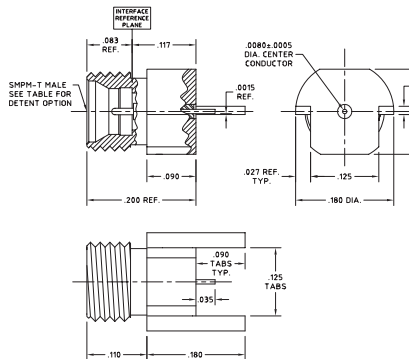

HUBER+SUHNER type	Item no.	Detent
29976BM-2-006	80367075	full
29976BM-4-006	80367222	smooth bore

SMPM-T – adaptors

Adaptor SMPM-T plug – SK (2.92 mm standard) plug (male/male)

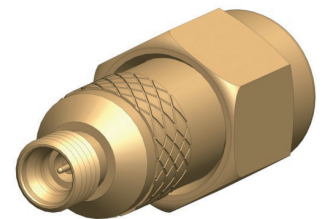
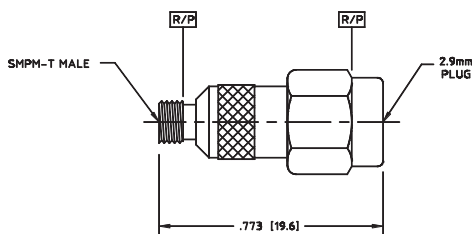

HUBER+SUHNER type	Item no.	Packaging	Detent
29429-1T2	80317870	single	full

Adaptor SMPM-T plug – SK (2.92 mm standard) jack (male/female)

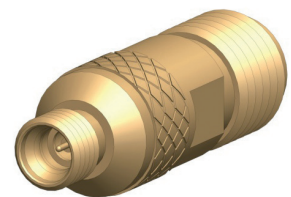
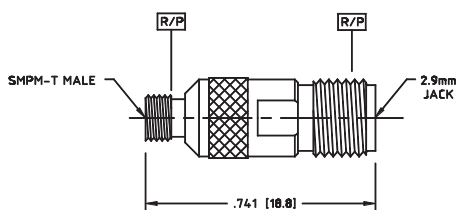

HUBER+SUHNER type	Item no.	Packaging	Detent
29429-4T2	80362561	single	full

SMP Self Lock «SMP-SL»

Push-on connector that doesn't pull off

Threaded connectors

- Most common interface for space-flight applications
- Secured connection under vibration and shock levels
- Torque tools entail excessive installation time and cost

Push-on connectors

- SMP connector
- Utilized to minimize installation time
- Low endurance of the interface under severe environmental conditions
- Limited use in aerospace applications
- SMP Self Lock «SMP-SL»
- Flight ready push-on connector operating up to Ka-band (40 GHz)
- Greatly reduces the installation time
- Retains the durability of a threaded connector
- Does not exceed the standard SMP connector envelope

Design features and benefits

- Single audible click when locked
- Red colored locking ring provides a visual inspection point
- Retains the small form factor of a standard SMP interface per MIL-STD-348
- Risk for unintentional de-mating eliminated – dedicated removal tool needed
- 66 % lower mass compared to equivalent solutions in the market

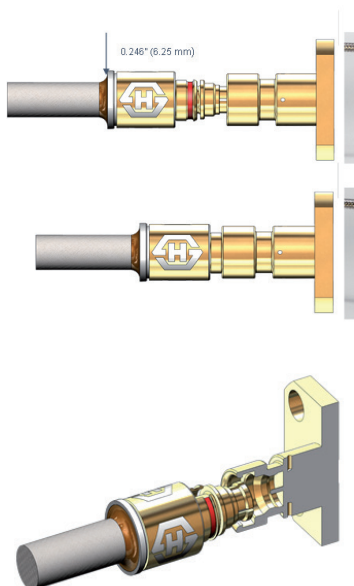

SMP-SL: product portfolio

HUBER+SUHNER cables supporting SMP-SL

- Mini141
- Minibend® L

Adaptors

- SMP-SL plug to SK plug
- SMP-SL jack to SK plug
- SMP-SL plug to SK jack
- SMP-SL jack to SK jack
- Various PCB and flanged connectors
- Custom de-mating tools
- Additional SMP-SL configurations available on request.



Power Sub-Miniature «PSM»

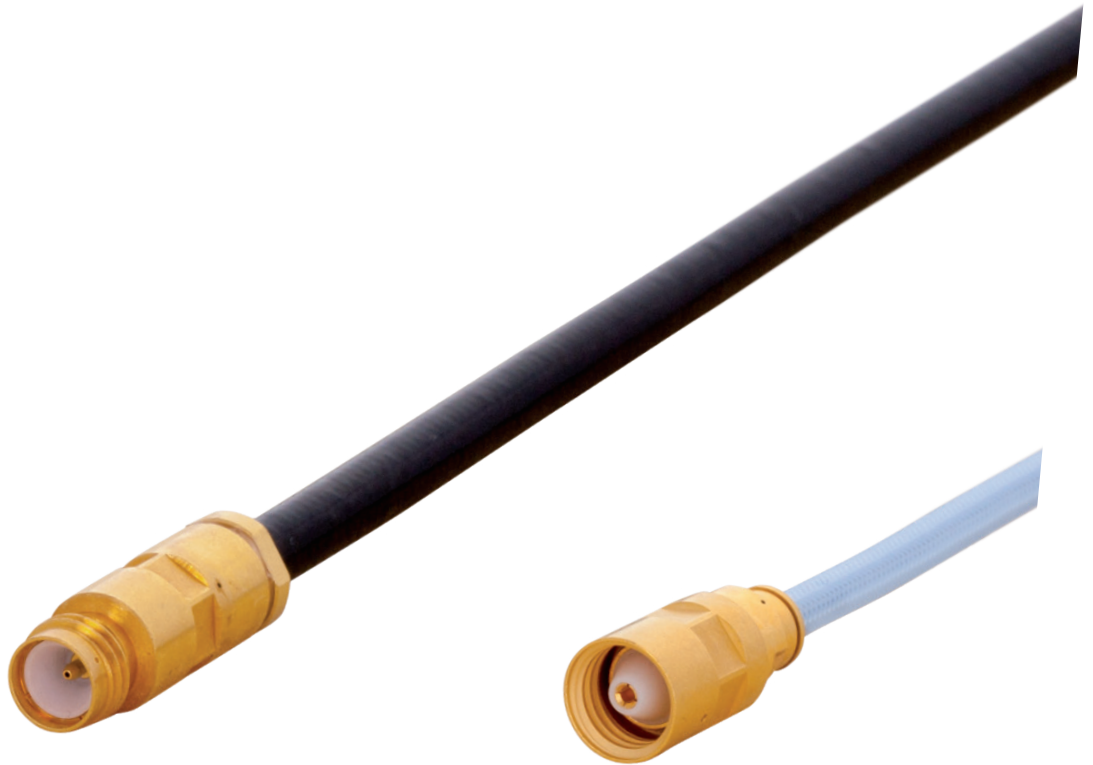

PSM (Power Sub Miniature) interface meets the increasing demand of cost effective, power and weight sensitive Aerospace applications. Especially developed for Space Flight, High Altitude Platforms and TVAC environments. Space qualified per MIL-PRF-39012 and ESCC 3402. The PSM connector family has the size and weight of an SMA and the power handling capabilities of a standard TNC per MIL-PRF-39012 and MIL-STD-348. The PSM connector system enables customers to maximize performance on power handling while minimizing overall system weight and size. Multipaction breakdown and corona withstanding meet or exceed TNC interface level.

Features and benefits

Power handling capabilities like a TNC per MIL-PRF-39012.

- SMA size and weight
- Multipaction and Corona resistant
- Non magnetic and low PIM
- Space qualified
- Cable assemblies, panel connectors and adaptors

PSM – technical data

Electrical data	Requirements
Impedance	50 Ω
Frequency range	DC-18 GHz
Return loss	see table below
Insertion loss	0.05 dB typ.
RF leakage	< -90 dB
Working, dielectric and RF voltage	driven by multipactor requirements
Corona threshold	peak power 800 W
High power handling under vacuum	1 GHz: 150 W (CW) 4 GHz: 76 W (CW) 12 GHz: 40 W (CW)
Multipactor threshold 20 μ s, 2 % duty cycle	peak power 800 W
PIM performance, 2 x 20 W	-168 dBc (3rd order power at 1900 MHz)
Insulation resistance	> 5000 M Ω
Contact resistance – centre conductor outer conductor	< 2 m Ω < 2 m Ω

Return loss (typical values)	Frequencies			
	1 GHz	4 GHz	12 GHz	18 GHz
Connector straight	36 dB (1.03)	31 dB (1.06)	28 dB (1.08)	26 dB (1.10)

Mechanical data	Requirements
Recommended coupling nut torque	\geq 1.5 Nm/13.3 in lbs
Coupling nut retention force	\geq 250 N/56.2 lbs
Contact captivation	\geq 27 N/6.1 lbs
Cable retention force	\geq 100 N/22.5 lbs
Durability (matings)	\leq 100

Environmental data	Requirements
Temperature range	-65 to +165 °C (thermal vacuum test)
Thermal shock	MIL-STD-202, method 107 condition B
Moisture resistance	MIL-STD-202, method 106
Corrosion	MIL-STD-202, method 101 condition B
Sine vibration	MIL-STD-202, method 204, 28 g peak
Random vibration	MIL-STD-202, method 214 condition K-1, 46.3 g
Shock	MIL-STD-202, method 213, 12000 g peak

Space qualified per	MIL-PRF-39012, ESCC 3402
---------------------	--------------------------

Material data

Connector part	Material	Plating
Bodies	copper-beryllium alloy	gold
Pin contacts	copper-beryllium alloy	gold
Coupling nuts	copper-beryllium alloy	gold
Insulator	PTFE	--

PSM – cables

Pre-terminated cable assemblies with straight male and female PSM connectors are available with Mini141H, SucoFlex 329, semi-rigid 141 low loss and semi-rigid 141 standard.

	Mini 141 H 32021E	SUCOFLEX 329	35000	30141 EZ 141
Type	flexible	flexible	semi-rigid	semi-rigid
Type of junction	solderless	soldered	soldered	soldered
Velocity nominal (%)	76.5	84.0	82.0	69.5
RF leakage assembly (dB) at 18 GHz	> 110	> 90	> 100	> 100
Static bend radius (inch min.) / [mm min.]	0.33 / [8.38]	0.90 / [23]	0.75 / [19.05]	0.12 / [3.18]
Weight (lbs/100 ft nom.) / [g/m]	2.70 / [40.20]	2.70 / [40.20]	2.75 / [40.95]	1.07 / [30.5]
Insertion loss at 18 GHz (dB/100 ft) / [dB/m]	62 / [2.03]	35 / [1.15]	45 / [1.48]	59 / [1.93]
OD max. diameter (in) / [mm]	144 / [3.68]	210 / [5.33]	141 / [3.58]	141 / [3.58]
Shields	5	3	–	–
Dielectric	Microporous PTFE	Microporous PTFE	Microporous PTFE	PTFE

Insertion loss (cable only)

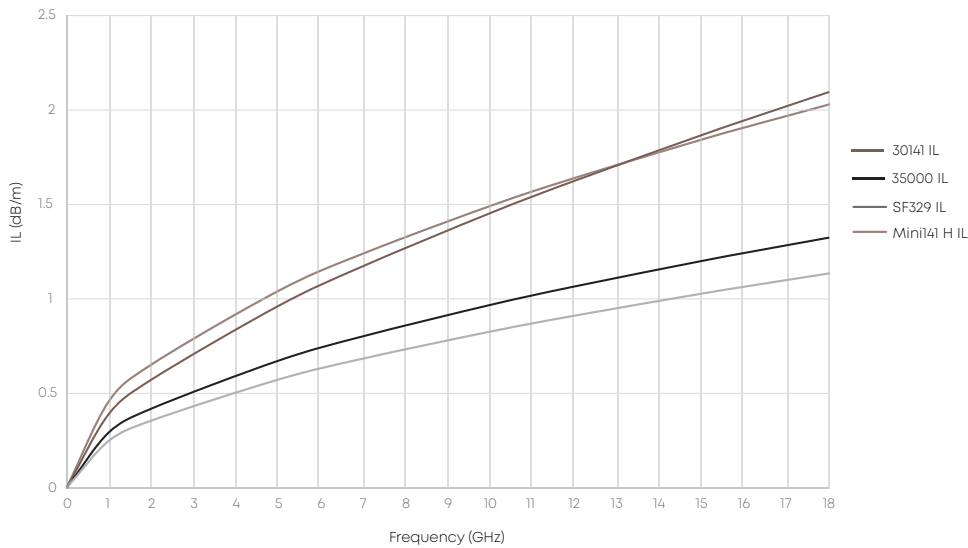

Straight panel receptacle and surface mount

- Flange mount
- Surface mount
- Direct replacement for SMA
- DC to 18 GHz



HUBER+SUHNER part number	Item no.	
23_PSM-50-0-2/111_UE	80351702	
96_PSM-50-0-1/111_NE	80351697	

PSM – adaptors

Within series



PSM/PSM	HUBER+SUHNER part number	Item no.
	31_PSM-PSM-50-1/11-_UE	80351700
Gender	female/jack	
Material	CuBe/gold	
VSWR	≤ 1.10 DC - 14* GHz	

In between series



PSM/TNC Hermetic	HUBER+SUHNER part number	Item no.
	34_PSM-TNC-50-1/111_NE	80351699
PSM	female/jack	
TNC	female/jack	
Material PSM	CuBe/gold	
Material TNC	center contact CuBe/gold body & mounting nut SS 303	
VSWR	≤ 1.10 DC - 10* GHz	



TNC/PSM	HUBER+SUHNER part number	Item no.
	33_TNC-PSM-50-1/119_UE	80351698
TNC	male/plug	
PSM	female/jack	
Material TNC	SS corrosion resistant, non-magnetic. nut and center contact CuBe/gold. nut: black chemical finish MIL-F-495	
Material Heat sink	aluminum black anodized	
Material PSM	SS corrosion resistant, non-magnetic	
VSWR	≤ 1.10 DC - 14* GHz	

* Frequency limited due to power handling capacity.

Customized connectors/ design capabilities

The connector product portfolio qualified for use in space is designed for the most unique and difficult customer applications. The array of connector interfaces, panel mount geometries, printed circuit board (PCB) launch profiles, and customized design solutions is growing dynamically in response to the high technical demands of our customers. The materials selection of our connectors meets or exceeds the requirements of MIL-PRF-39012. The connectors can be designed to incorporate either mechanically captivated contacts or the contacts can be provided uninstalled to the customer.

Panel mount and PCB launch connectors are designed taking into account the unique design constraints of each customer application to provide optimized electrical and mechanical performance in any mounting style or launch topography.

Several options are available for specific application requirements such as low-Passive Intermodulation (PIM), epoxy staking, and high RF shielding performance. We also offer rigorous special process control support to provide PCB connectors that will not suffer from the effects of solder joint gold embrittlement.

Optimized connector/PCB Solutions

Only by using an optimized footprint can the performance of the connectors be unleashed. HUBER+SUHNER offers optimized connector/board solutions based on your actual designs:

- 3D field simulation
- Optimized footprints (incl. connector) as gerber files

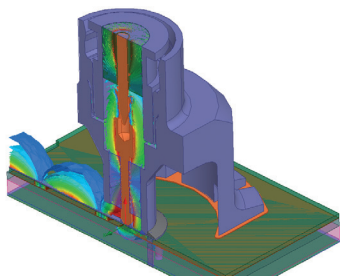

Application Engineering

HUBER+SUHNER has a team of specialists supporting your specific application. We have more than 25 years of experience within the industry and have successfully participated in many programs. Make use of our broad knowledge on connectors, cables and cable assemblies.

MMBX for space

The first two Galileo satellites have been orbiting the Earth since October 2011. They were joined by a second pair in October 2012. These four satellites have been used to test the infrastructure's functional capacity, both in space and on the ground. Further satellites will enter orbit during the following years, featuring radio frequency connectors from HUBER+SUHNER for connecting the navigation antenna to the satellite.



Since the radio frequency power was increased during Galileo's development, the various components involved also needed to be modified to meet the new requirements. HUBER+SUHNER is providing custom specific connectors based on the MMBX board-to-board solution that are capable of transferring the higher power level required. These connectors feature a special design with excellent properties to improve the high power transmission (no multipactor effect), the overall PIM performance, cope with the mechanical misalignment and excellent return loss. The full performance is guaranteed over the full range of temperature (-120 to +120 °C).

To ensure that the individual parts meet the strict ESA requirements for use in space, they are assembled in our cleanroom facility at HUBER+SUHNER.

High density connectors

High density solutions help saving on installation time, weight, space and eliminating routing errors during integration.

- Based on 67 GHz MIL-STD-348 SMPM interface.
- Keyed harnesses for effortless channel traceability.
- Threaded locking nuts and guiding pins guarantee electrical and mechanical performance under harshest conditions.

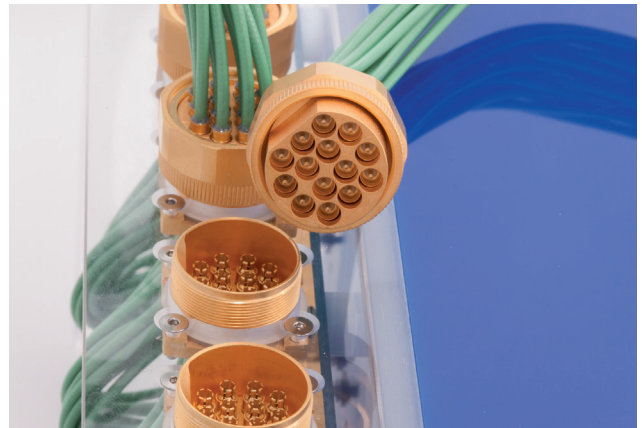
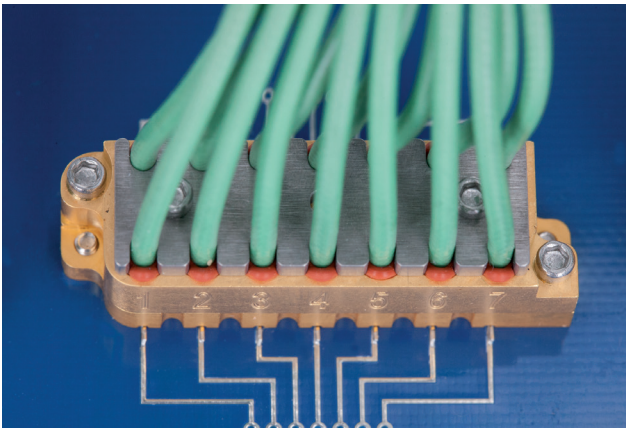

- Smallest possible centerline to centerline distance guarantee highest channel density with smallest PCB foot-print.
- The low mass connector design in combination with the highly flexible and solderless minibend cable assemblies offer compact and low mass RF connectivity up to 67 GHz.

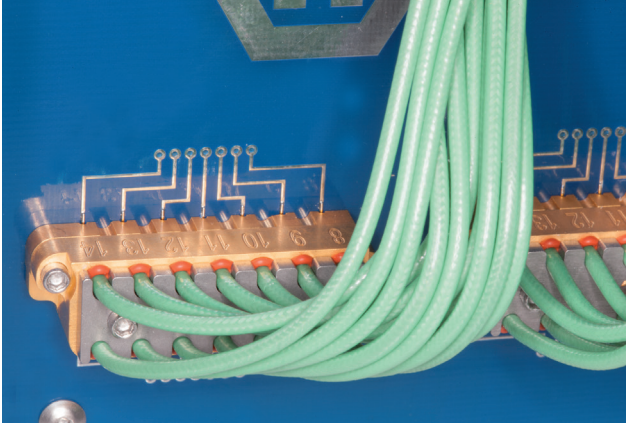

- Custom channel configurations are available on request

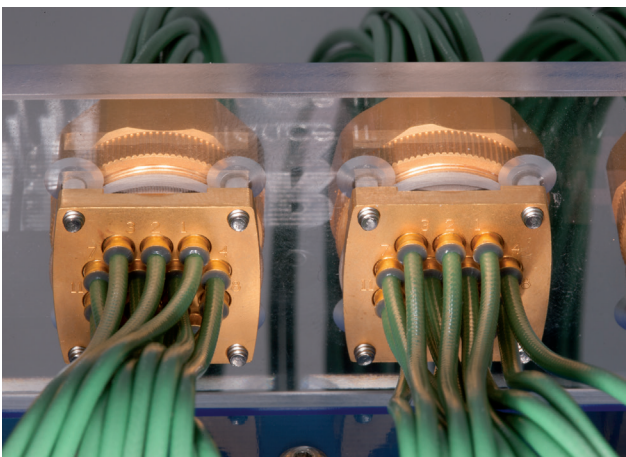

TVAC cable assemblies



Simulating the extreme conditions encountered in space imposes severe requirements on all components, from the test subject inside the thermal vacuum chamber through to the measurement installations on the outside. Exposure to rapid, large-scale thermal gradients within a vacuum environment requires carefully selected materials and designs that can mechanically and electrically withstand these extremes without the risk of multipaction and corona phenomena.

The use of high-power, low-outgassing materials, precision connector designs and innovative manufacturing techniques has allowed HUBER+SUHNER to provide durable, reliable TVAC cable assemblies and connector solutions for our customers within a broad range of TVAC applications.

Features

- In-house thermal aging of components
- Low outgassing materials in accordance with ECSS-Q-ST-70-02 C and NASA reference publication 1124
- Superior mechanical and electrical stability
- Perfectly matched cables and connectors from a single manufacturer
- Cable assemblies and components available for extremely high-power applications

Benefits

- Vented connectors for fast evacuation
- Longer lifetime, lower costs
- Customized configurations available

SUCOFLEX 100 TVAC – the versatile all-rounder

- Frequency range up to 65 GHz
- Perfectly matched cables and connectors from one manufacturer
- Broad range of cables and connectors available
- Pure jacket and arms for superior flexibility
- Vented connectors
- Armed options available



SUCOFLEX 200 TVAC – the high performance solution

- Frequency range up to 40 GHz
- Ultra low loss: typ. 1 dB/m at 18 GHz
- Fully MIL/DTL-17 qualified
- Extended temperature range



32071 TVAC – for high power applications

- Frequency range up to 14 GHz
- Capable of 500 WCW power handling in an ambient environment of +150 °C and vacuum conditions
- Extensive thermal ageing and stabilisation of the cable assembly is a standard manufacturing process
- Straight TNC, N and SC connectors
- High reliability



Phase stable over temperature raw cables and assemblies

The HUBER+SUHNER CT product family is developed for phase critical applications requiring precision electrical length connectivity. Thus, it creates a stable and reliable interconnect solution to satisfy a huge range of customer applications where phase stability is key. These products provide the industry leading phase vs. temperature performance, as well as a unique range of cable constructions to fulfil any customer TVAC demands.



SUCOFLEX® 100 TVAC



Electrical specifications	
Impedance (nominal)	50 Ω
Operating frequency	DC – 67 GHz
Velocity of propagation	77 % 71 % (SF 167)
Insertion loss variation vs. temperature	≤ 0.0021 °K ⁻¹ ≤ 0.0018 °K ⁻¹ (SF 167)
Return loss (typical)	> 25 dB @ 6 GHz > 21 dB @ 12 GHz > 20 dB @ 18 GHz > 19 dB @ 40 GHz > 16 dB @ 67 GHz
Capacitance	87 pF*m ⁻¹ 95 pF*m ⁻¹ (SF 167)
Time delay	4.3 ns*m ⁻¹ 4.7 ns*m ⁻¹ (SF 167)

Materials and finishes (according to ASTM-B 298)	
Cable centre conductor	solid silver-plated copper wire P: stranded silver-plated copper wire
Cable dielectric	low density extruded PTFE
First outer conductor	helically wrapped silver-plated copper tape
Second outer conductor	silver-plated copper wire
Cable jacket	solid extruded FEP

Cable mechanics		
Minimum bending radius – static	SF 101	11 mm
	SF 102	12 mm
	SF 103	13 mm
	SF 104	16 mm
Minimum bending radius – dynamic	SF 101	20 mm
	SF 102	20 mm
	SF 103	22 mm
	SF 104	25 mm
	SF 126	16 mm
	SF 106	24 mm
	SF 167	10 mm
	SF 126	25 mm
	SF 106	40 mm
	SF 167	20 mm

Weight		
SUCOFLEX cable	SF 101	36 g*m ⁻¹
	SF 102	40 g*m ⁻¹
	SF 103	53 g*m ⁻¹
	SF 104	84 g*m ⁻¹
	SF 126	70 g*m ⁻¹
	SF 106	157 g*m ⁻¹
	SF 167	21 g*m ⁻¹

Environmental specifications	
Temperature range	-55 to +85/+100/+125 °C depending on connectors and armoring

SUCOFLEX® 200 TVAC



Electrical specifications	
Impedance (nominal)	50 Ω
Operating frequency	DC – 40 GHz
Velocity of propagation	82 %
Insertion loss variation vs. temperature	≤ 0.002 °K ⁻¹
Return loss (typical)	> 25 dB @ 6 GHz > 24 dB @ 12 GHz > 23 dB @ 18 GHz > 19 dB @ 40 GHz
Capacitance	81 pF*m ⁻¹
Time delay	4.08 ns*m ⁻¹

Materials and finishes (according to ASTM-B 298)	
Cable centre conductor	solid silver-plated copper wire
Cable dielectric	low density tape wrapped PTFE
Cable shield	helically wrapped silver plated copper flat wire
Cable braid	solid silver-plated copper wire
Cable jacket	solid extruded FEP

Cable mechanics		
Minimum bending radius	– static	SF 229 23 mm SF 240 8.4 mm
	– dynamic	SF 229 70 mm SF 240 25.2 mm

Weight	
SUCOFLEX cable	SF 229 61g*m ⁻¹
	SF 240 31 g*m ⁻¹

Environmental specifications	
Temperature range	-65 to +200 °C

High power 32071 TVAC

- Frequency range up to 14 GHz
- Capable of 500 W CW power handling in an ambient environment of +150 °C and vacuum conditions
- Extensive thermal ageing and stabilisation of the cable assembly is a standard manufacturing process
- Straight TNC, N and SC connectors
- High reliability



Electrical specifications	
Impedance (nominal)	50 Ω
Velocity %	78
Operating frequency	DC – 14 GHz
Insertion loss variation vs. temperature	< 0.0015 °K-6
Return loss (min)	-25 dB @ 2 GHz -27 dB @ 14 GHz
RF leakage	95 dB
Resistance – insulation cable	> 106 MΩ*m
Withstand voltage – cable assembly (at sea level)	> 10 000 V
Capacitance	85.9 pF*m-6
Time delay	4.28 ns*m-6
Phase variation vs. temperature	< 1500 ppm

Materials and finishes	
Cable center conductor	silver plated solid copper
Cable dielectric	tape wrapped PTFE
Cable shield	silver plated copper helical foil
Cable binder	silver plated flat copperwire braid
Cable jacket	extruded FEP

Cable mechanics	
Diameter	9.40 mm
Minimum bending radius – static	50.8 mm
Minimum bending radius – dynamic	152.4 mm
Cable retention force on ruggedized cable assemblies	135 N
Weight	208.4 g*m-1

Environmental specifications	
Temperature range	-55 to +200°C
Radiation resistance	30 Mrad
Out gassing according ECSS-Q-ST-70-02 and NASA reference publication 1124	TML < 1 %, CVCM < 0.1 %

SUCOFLEX® TVAC – portfolio

Assembly type	Freq. range	Connectors	Temperature range	Special benefit
SUCOFLEX 102 TVAC	DC – 40 GHz	11_SK-263_TVAC (2.92)	-55 to +125 °C	
SUCOFLEX 103 E TVAC	DC – 33 GHz	11_SK-312_TVAC (2.92)	-40 to +85 °C	flexible jacket
SUCOFLEX 103EA TVAC	DC – 33 GHz	11_SK-312_TVAC (2.92)	-40 to +85 °C	armour type A
SUCOFLEX 104 TVAC	DC – 18 GHz	11_SMA-454_TVAC	-55 to +125 °C	
	DC – 26.5 GHz	11_PC35-411_TVAC (3.5)	-55 to +125 °C	
	DC - 18GHz	11_TNC_476_TVAC	-55 to +125 °C	
SUCOFLEX 104E TVAC	DC – 18 GHz	11_SMA-454_TVAC	-40 to +85 °C	flexible jacket
	DC – 26.5 GHz	11_PC35-411_TVAC (3.5)	-40 to +85 °C	
	DC - 18GHz	11_TNC_476_TVAC	-40 to +85 °C	
SUCOFLEX 104EA TVAC	DC – 18 GHz	11_SMA-454_TVAC	-40 to +85 °C	armour type A flexible jacket
	DC – 26.5 GHz	11_PC35-411_TVAC (3.5)	-40 to +85 °C	
	DC - 18GHz	11_TNC_476_TVAC	-55 to +85 °C	
SUCOFLEX 126 TVAC	DC – 18 GHz	11_SMA-454_TVAC	-55 to +125 °C	stranded center conductor
	DC – 26.5 GHz	11_PC35-411_TVAC (3.5)	-55 to +125 °C	
	DC - 18GHz	11_TNC_476_TVAC	-55 to +125 °C	
SUCOFLEX 126E	DC – 18 GHz	11_SMA-454_TVAC	-40 to +85 °C	flexible jacket stranded center conductor
	DC – 26.5 GHz	11_PC35-411_TVAC (3.5)	-40 to +85 °C	
	DC - 18GHz	11_TNC_476_TVAC	-40 to +125 °C	
SUCOFLEX 126EA	DC – 18 GHz	11_SMA-454_TVAC	-40 to +85 °C	armour type A stranded center conductor
	DC – 26.5 GHz	11_PC35-411_TVAC (3.5)	-40 to +85 °C	
	DC - 18GHz	11_TNC_476_TVAC	-40 to +85 °C	
SUCOFLEX 167 TVAC	DC – 67 GHz	11-PC185-27 (1.85)	-55 to +165 °C	
SUCOFLEX 229 TVAC	DC – 29 GHz	SMA 26.5 SK (2.92) TNC N	-65 to +200 °C	phase stable low insertion loss
SUCOFLEX 240 TVAC	DC – 40 GHz	SMA SK (2.92)	-65 to +200 °C	phase stable low insertion loss
32071 TVAC	DC – 14 GHz	TNC, SC	-70 to +200 °C	see power handling
MULTIFLEX_141_CT	DC – 33 GHz	SK (2.92) SMA	-65 to +200 °C	phase stable
MULTIFLEX_210_CT	DC – 30 GHz	SK (2.92) SMA	-65 to +200 °C	phase stable
MULTIFLEX_318_CT	DC – 18 GHz	N TNC	-65 to +200 °C	phase stable

SUCOFLEX® 100 – series TVAC

Insertion loss vs. frequency

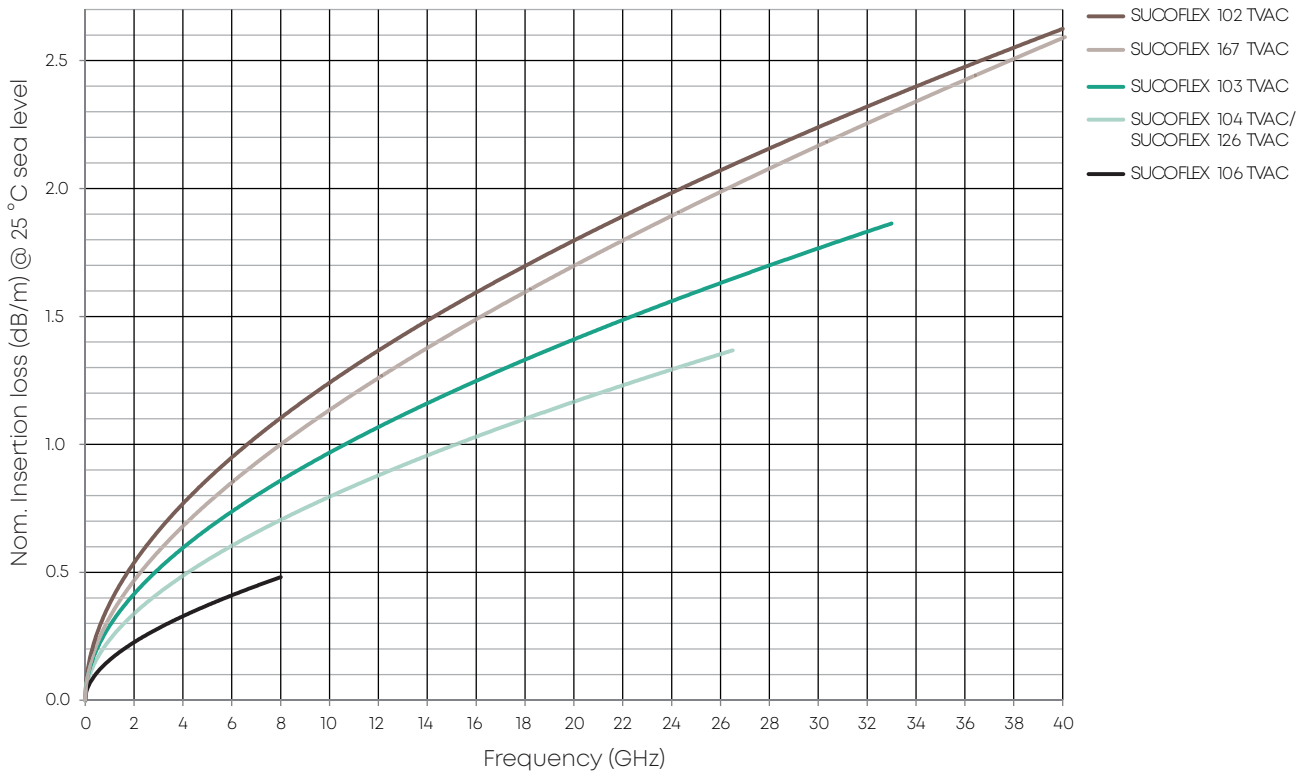

CW power SUCOFLEX® 126 TVAC with TNC connectors

CW power max. vs. frequency

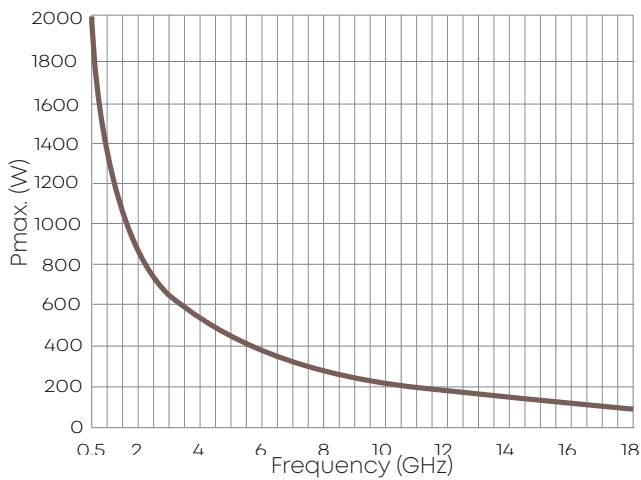

— SUCOFLEX 126 TVAC with TNC connectors

Derating factor

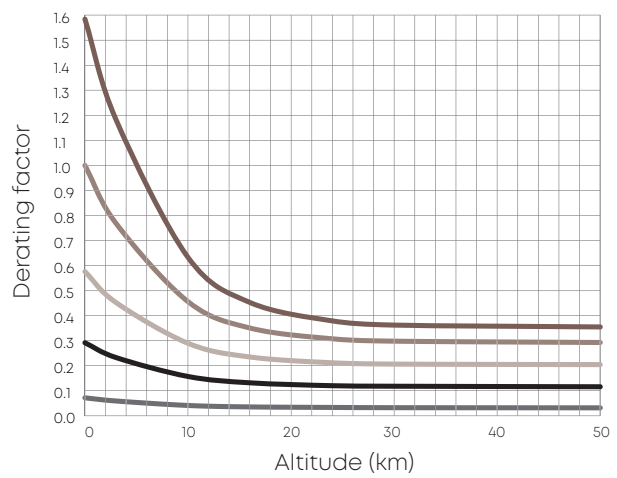

— T = -55 °C — T = 125 °C
 — T = 25 °C — T = 155 °C
 — T = 85 °C

CW power SUCOFLEX® 106 TVAC with TNC connectors

CW power max. vs. frequency

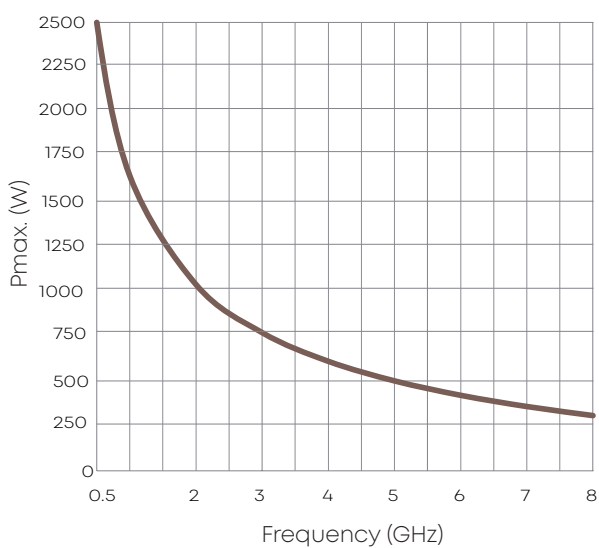

— SUCOFLEX 106 TVAC with TNC connectors

Derating factor

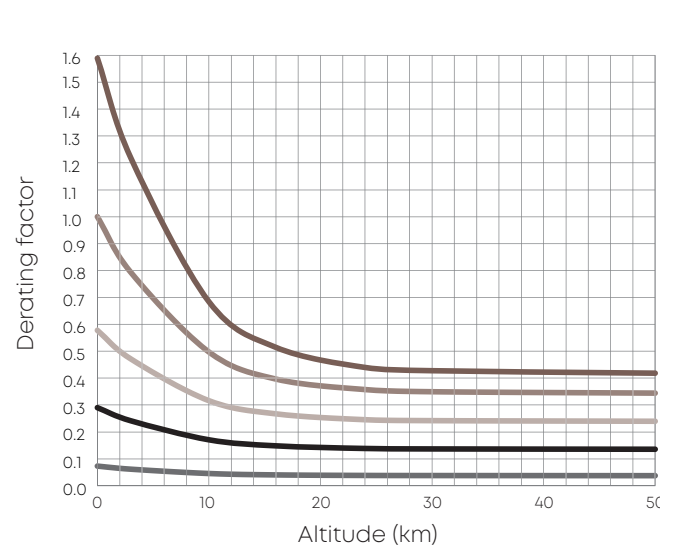

— T = -55 °C — T = 125 °C
 — T = 25 °C — T = 155 °C
 — T = 85 °C

SUCOFLEX® 200 TVAC series and 32071 TVAC

Insertion loss vs. frequency

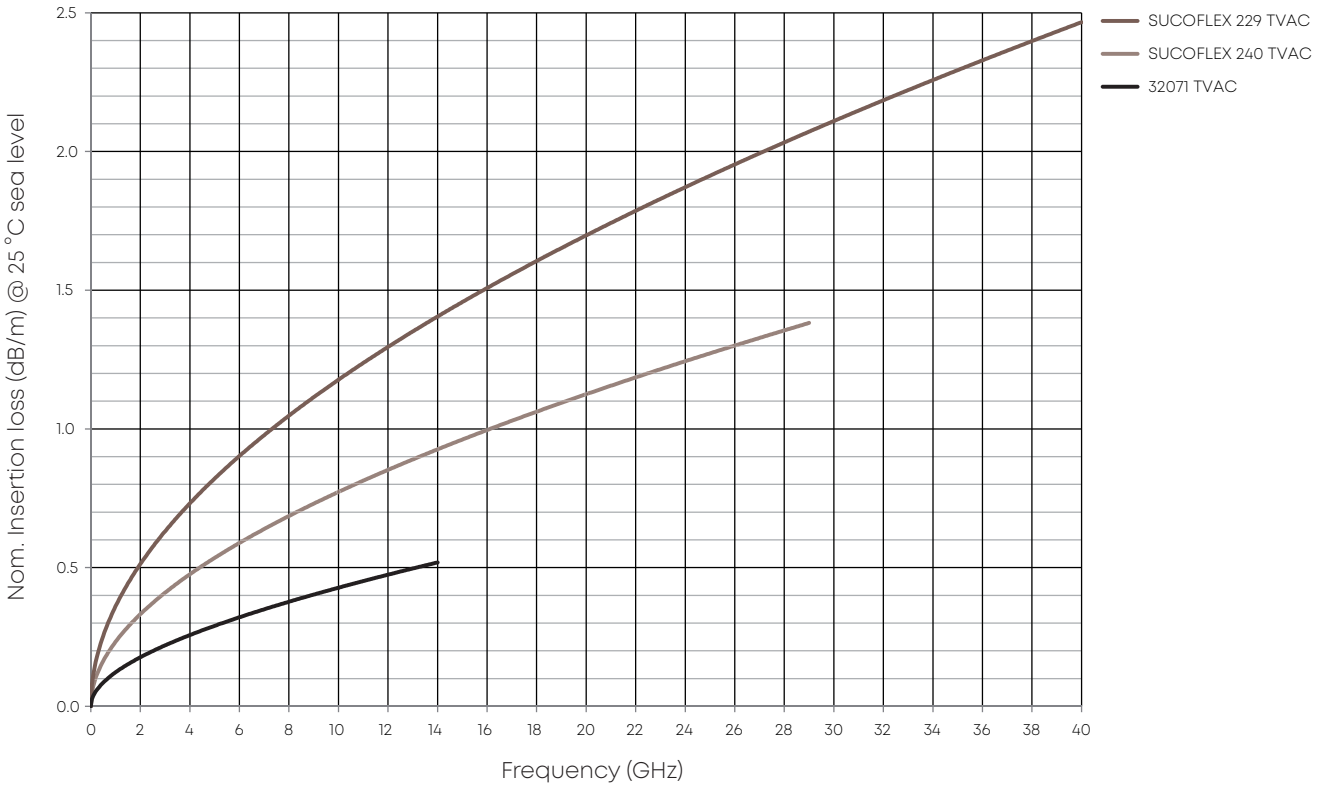

CW power 32071 with TNC connectors

CW power max. vs. frequency

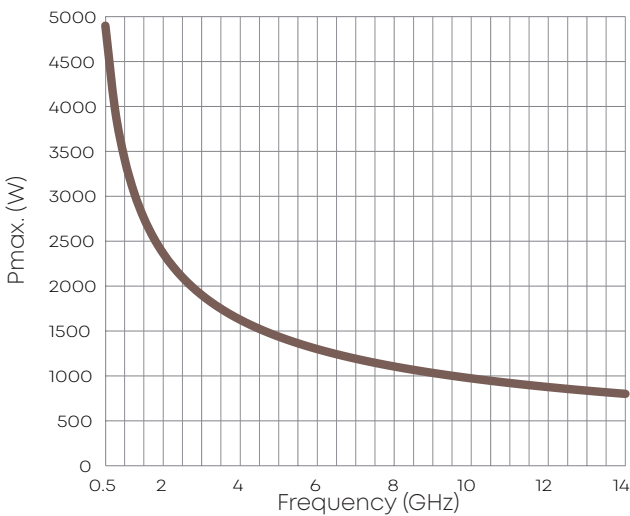

32071 TVAC with TNC connectors

Derating factor

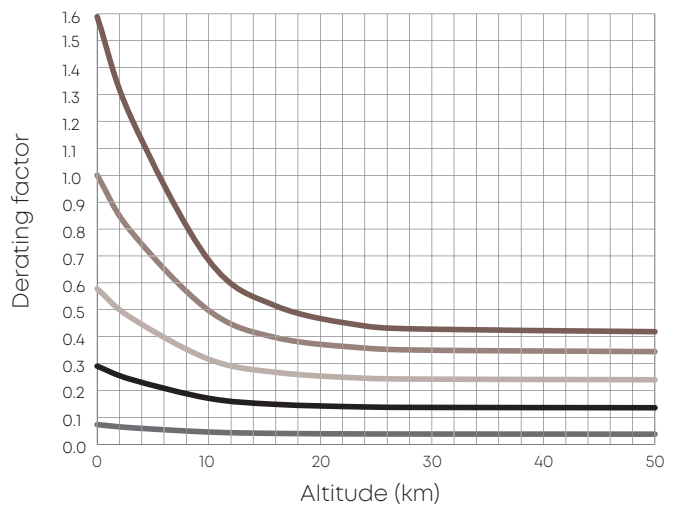

T = -55 °C
T = 25 °C
T = 85 °C
T = 125 °C
T = 155 °C

Thermal vacuum hermetic sealed adaptors

HUBER+SUHNER offers a wide array of hermetic feed-thru style adaptors that offer both in-series and between series interface solutions for TVAC testing applications. The hermeticity is provided through a glass-fired seal within the adaptor body. The glass material is selected to provide the best electrical performance while also matching the coefficient of thermal expansion of the surrounding body and contact as closely as possible to prevent any loss of hermeticity. All of the hermetic adaptors are 100 % tested for hermeticity in accordance with ASTM E-498, MIL-STD-202, and MIL-STD-883. The guaranteed leakage rate is less than 1×10^{-8} ccm/second of helium under a pressure differential of 15 psig (1 bar).



2.9 mm jack – 2.9 mm jack, jack hermetic/29485G-4

Impedance	nominal	50 Ω
Frequency	max.	40 GHz
Insertion loss	max.	1.00 dB
VSWR	max.	1.50 : 1
Temperature range		-55 to +125 °C
Standard		MIL-STD-348
Hermetic seal		ASTM E-498, MIL-STD-202 and MIL-STD-883



TNC jack – TNC jack, bulkhead, hermetic/29396G-1

Impedance	nominal	50 Ω
Frequency	max.	10 GHz
Insertion loss	max.	0.60 dB
VSWR	max.	1.35 : 1
Temperature range		-55 to +125 °C
Standard		MIL-STD-348
Hermetic seal		ASTM E-498, MIL-STD-202 and MIL-STD-883



N jack – N jack, bulkhead, hermetic/29304G

Impedance	nominal	50 Ω
Frequency	max.	11 GHz
Insertion loss	max.	0.80 dB
VSWR	max.	1.20 : 1
Temperature range		-55 to +125 °C
Standard		MIL-STD-348
Hermetic seal		ASTM E-498, MIL-STD-202 and MIL-STD-883

Thermal vacuum hermetic sealed adaptors



SMA jack – SMA jack, bulkhead, hermetic/29285G

Impedance	nominal	50 Ω
Frequency	max.	22 GHz
Insertion loss	max.	0.55 dB
VSWR	max.	1.30 : 1 (10 GHz)/1.45 : 1 (22 GHz)
Temperature range		-55 to +125 °C
Standard		MIL-STD-348
Hermetic seal		MIL-STD-202, MIL-STD-883 and ASTM E-498



SMA jack – N jack, hermetic/29033-0G

Impedance	nominal	50 Ω
Frequency	max.	8 GHz
Insertion loss	max.	0.35 dB
VSWR	max.	1.25 : 1
Temperature range		-55 to +125 °C
Standard		MIL-STD-348
Hermetic seal		MIL-STD-202, MIL-STD-883 and ASTM E-498



SMA jack – TNC jack, bulkhead, hermetic/29003-0-3G

Impedance	nominal	50 Ω
Frequency	max.	10 GHz
Insertion loss	max.	0.35 dB
VSWR	max.	1.20 : 1
Temperature range		-55 to +125 °C
Standard		MIL-STD-348
Hermetic seal		MIL-STD-202, MIL-STD-883 and ASTM E-498

Space flight phase shifters



The phase shifter product family is designed for use in electronic systems where precision adjustment and tuning of transmission line electrical lengths are required. The phase shifter, or line trimmer, is designed to allow precise in-line phase change while maintaining constant VSWR and Insertion Loss performance values. The construction of the phase shifters incorporates fine gauge threads for precise tuning accuracy at a resolution of less than 0.1 degrees. A variety of interfaces and phase adjustment ranges are available with operation up to 26 GHz. These passive devices have proven successful in aerospace and satellite programs with flight heritage in both North America and Europe.

Type	Interfaces		Frequency range (GHz)		Total $\Delta\Phi$		VSWR		Dimension (mm)		Dimension (inch)	
	1	2	min	max.	min	max.	min	max.	closed	open	closed	open
40002C	SMA plug	SMA plug	0.1	4.0	4°	160°	1.05:1	1.28:1	108.71	143.00	4.28	5.63
40003C	SMA plug	SMA jack	0.1	4.0	4°	160°	1.05:1	1.28:1	105.66	139.95	4.16	5.51
40004C	SMA jack	SMA jack	0.1	4.0	4°	160°	1.05:1	1.28:1	103.38	137.67	4.07	5.42
40019C	N plug	TNC jack	0.1	4.0	4°	160°	1.15:1	1.35:1	117.86	152.15	4.64	5.99
40020C	TNC jack	TNC jack	0.1	4.0	4°	160°	1.15:1	1.35:1	129.79	164.08	5.11	6.46
40002A	SMA plug	SMA plug	0.5	8.0	35°	570°	1.08:1	1.25:1	159.00	218.44	6.26	8.60
40003A	SMA plug	SMA jack	0.5	8.0	35°	570°	1.08:1	1.25:1	155.96	215.39	6.14	8.48
40004A	SMA jack	SMA jack	0.5	8.0	35°	570°	1.08:1	1.25:1	153.67	213.11	6.05	8.39
40006A	N plug	N jack	0.5	8.0	33°	538°	1.08:1	1.25:1	164.34	220.47	6.47	8.68
40007A	N jack	N jack	0.5	8.0	33°	538°	1.08:1	1.25:1	163.07	219.20	6.42	8.63
40002B	SMA plug	SMA plug	8.0	18.0	97°	219°	1.25:1	1.40:1	58.42	68.58	2.30	2.70
40003B	SMA plug	SMA jack	8.0	18.0	97°	219°	1.25:1	1.40:1	53.37	65.58	2.18	2.58
40004B	SMA jack	SMA jack	8.0	18.0	97°	219°	1.25:1	1.40:1	52.07	62.23	2.05	2.45
40005B	N plug	N plug	8.0	18.0	102°	230°	1.25:1	1.40:1	73.91	84.58	2.91	3.33
40006B	N plug	N jack	8.0	18.0	102°	230°	1.25:1	1.40:1	73.15	83.82	2.88	3.30
40007B	N jack	N jack	8.0	18.0	102°	230°	1.25:1	1.40:1	68.83	79.50	2.71	3.13
40011B	N jack	SMA plug	8.0	18.0	92°	208°	1.25:1	1.40:1	60.71	70.36	2.39	2.77
40004D	SMA jack	SMA jack	8.0	26.0	146°	474°	1.25:1	1.37:1	56.90	72.90	2.24	2.87
40004E	SMA jack	SMA jack	8.0	26.0	146°	474°	1.25:1	1.37:1	56.90	72.90	2.24	2.87

Environmental qualification levels:

- Thermal shock: MIL-STD-202, Method 107, 100 cycles, -55/+125 °C
- Sine vibration: MIL-STD-202, Method 204, 21 g peak
- Random vibration: MIL-STD-202, Method 214, 26.1 g rms
- Mechanical shock: MIL-STD-202, Method 213, 750 g peak.

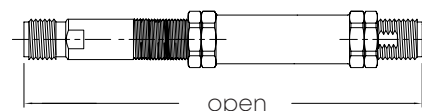
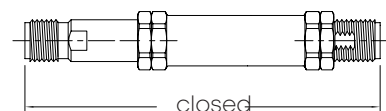

32071 high power cable assemblies



The 32071 cable assembly offers incredible benefits to not only withstand extreme temperature and high altitude conditions, but also provide outstanding performance at high power levels. Based on its Fluoroloy® loaded connectors we can guarantee up to 500 W CW power at 150 °C under vacuum.

In addition, HUBER+SUHNER provides a comprehensive array of Fluoroloy® loaded panel connectors and feed-throughs for high power applications. Fluoroloy® has a higher dielectric constant (as compared to standard Teflon dielectric), but also a higher rate of thermal conductivity. This provides a more effective and efficient transfer of the heat generated at the center conductor, thus increasing the power handling capability of the connector. Fluoroloy® dielectric is available as an option on all of our connector types, should the power levels of the application require it.

32071 – high power, low loss



Product description

Boa-flex II cables utilize a microporous PTFE dielectric for low loss with minimal phase change due to temperature changes and flexure. Typical velocity is 78 % of the speed of light. All offer very low loss and are extremely stable with flexure.

Product features

- Impedance 50 Ω
- Applicable up to 14 GHz
- Low density PTFE for superior electrical performance
- Helical wrapped outer conductor for increased electrical performance
- Exceptional phase and insertion loss stability with flexure
- Excellent phase vs. temperature characteristics
- Preferred for phase matching and tracking applications

Recommended connectors

32071	TNC, N, SC
	Others available

Construction

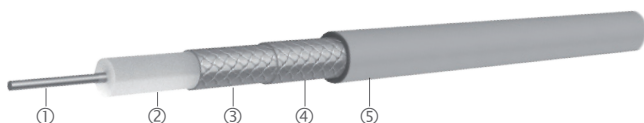

Cable	Inner conductor ①	Dielectric ②	Outer conductor ③	Outer braid ④	Jacket ⑤	Outer diameter
						mm
32071	CuAg solid	PTFE microporous	CuAg tape	CuAg	FEP, translucent amber	9.5

Technical data

Cable	Item no.	Max. operating frequency	Velocity of propagation	Weight	Min. bending radius		Temperature range
					static mm	dynamic mm	
32071	80310956	14 GHz	78 %	208.3 g/m	50.8	152.4	-55 to +200 °C

Available connectors

Connector	Series, pattern	HUBER+SUHNER type	Cable	Operating frequency	Item no.
				GHz	
TNC	straight cable plug	29614-32-71	32071	12.4	80318585
	straight high power cable plug	29614FLPV3-32-71		4.8	80378457
	straight vented cable plug	29614HTPV-32-71		12.4	80378181
N	straight cable plug	29602-32-71		12.4	80318491
	straight cable jack	29601-32-71		12.4	80318466
	straight bulkhead cable jack	29636-32-71		12.4	80340623
SC	straight cable plug	29608-32-71		10.0	80318547

32071 – graphs

Attenuation (nominal values at +25 °C ambient temperature)

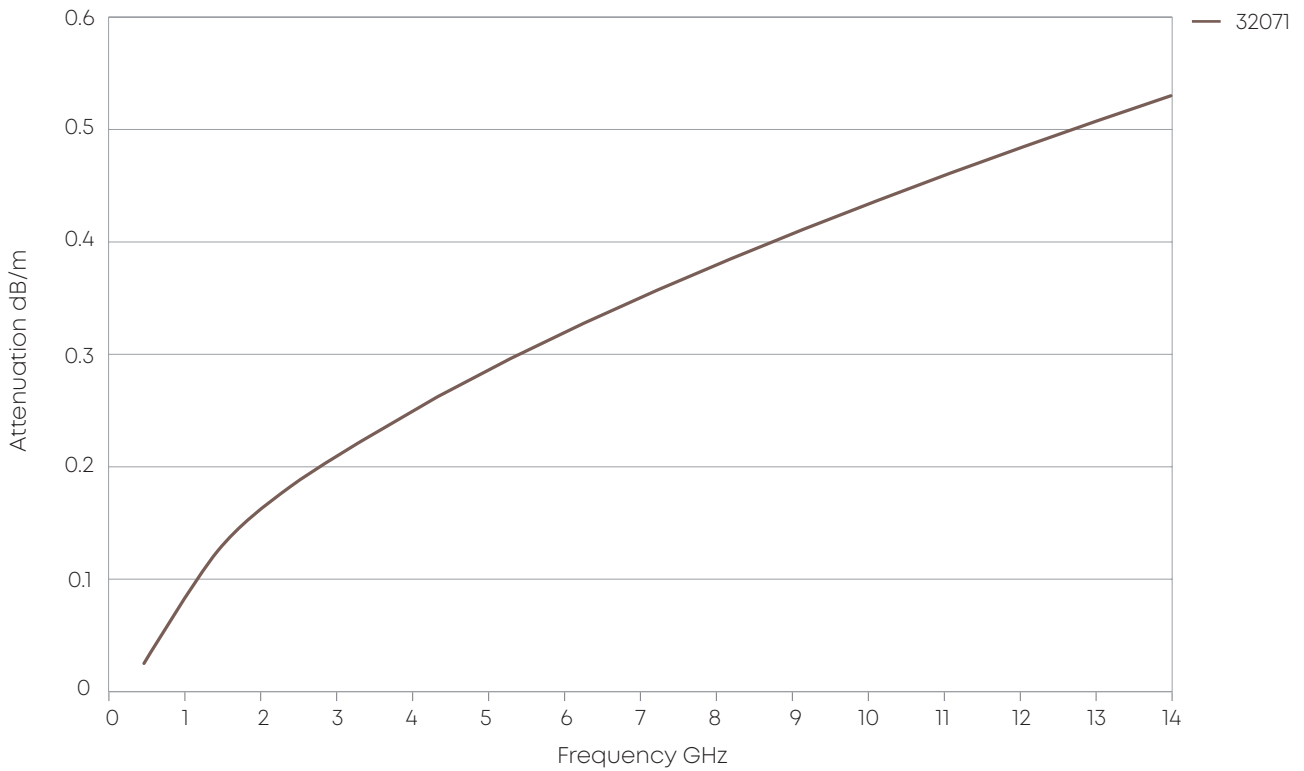

Power handling (maximum values at 25 °C ambient temperature and sea level)

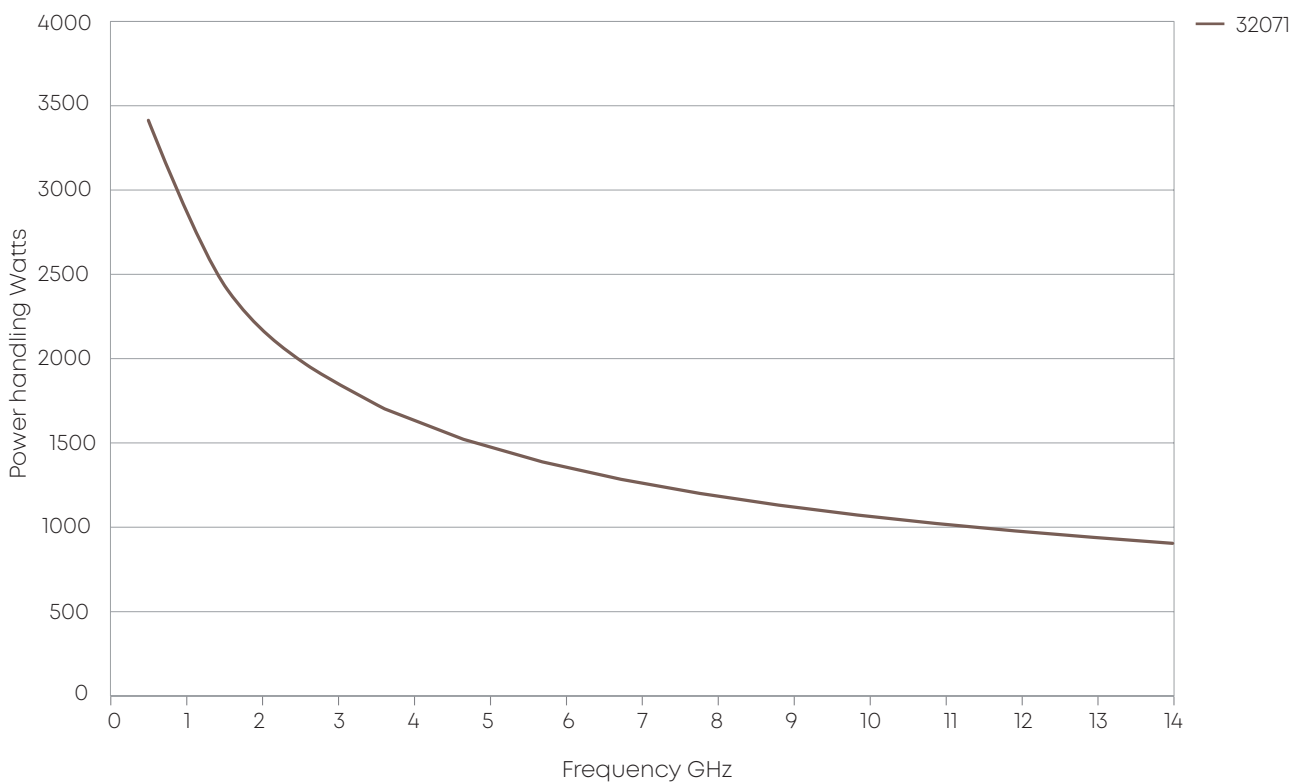

32071 – high power connectors and adaptors

29396G3-ELPV

- Hermetic TNC jack to TNC jack bulkhead adaptor
- Positively vented and pre-potted
- Frequency range up to 10 GHz
- Designed for high power and multipaction-free applications



29713-46ELPV

- Panel mount TNC jack connector
- Integrated heat sink for high power handling capability
- Positively vented and pre-potted
- Frequency range up to 14 GHz
- Designed for high power and multipaction-free applications



Spuma – the flexible low loss standard



The HUBER+SUHNER Spuma product family stands for lowest loss with halogen free materials. Shielding and VSWR are optimised up to 6 GHz. The cables are more flexible than corrugated ones, allowing easier handling and installation. Tight bending radii are possible. With this set of features, Spuma can support a multitude of application in various industries, including railway, defense, communication, instrumentation and others. Spuma products can also be used as drop-in replacement for LMR® (LMR® is a brand of Times Microwave Inc.).

Features

- 6 GHz
- Excellent insertion loss
- High flexibility due to rotary swaging technology

Benefits

- Highly efficient RF signal distribution
- Halogen free and flame retardant
- Easy to install

Spuma – most cost effective

The standard Spuma cables provide the full range of benefits of the series for general use applications.

Applications

- Outdoor use

Markets

- Wireless infrastructure
- Defense

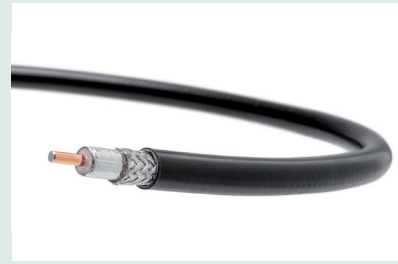

Spuma FR – flame retardant

The flame retardant Spuma cables provide great flame retardancy making the range viable for rolling stock and indoor applications.

Applications

- Outdoor and indoor use
- Railway approved:
 - EN 45545-2
 - NFPA 130

Markets

- Railway
- Defense
- Wireless infrastructure
- Industrial



Spuma RS FR – rotary swaged & flame retardant

The patented rotary swaging technology (low-loss strand) allows to overcome the common trade-off between flexibility and low attenuation. Furthermore, the new TPU jacket material provides flame retardancy without compromising on flexibility.

Applications

- Outdoor and indoor use
- Best compromise between loss and flexibility
- Environments with limited space

Markets

- Defense
- Test and measurements
- Railway



Spuma – graphs

Attenuation

Typical values at 20 °C ambient temperature and sea level

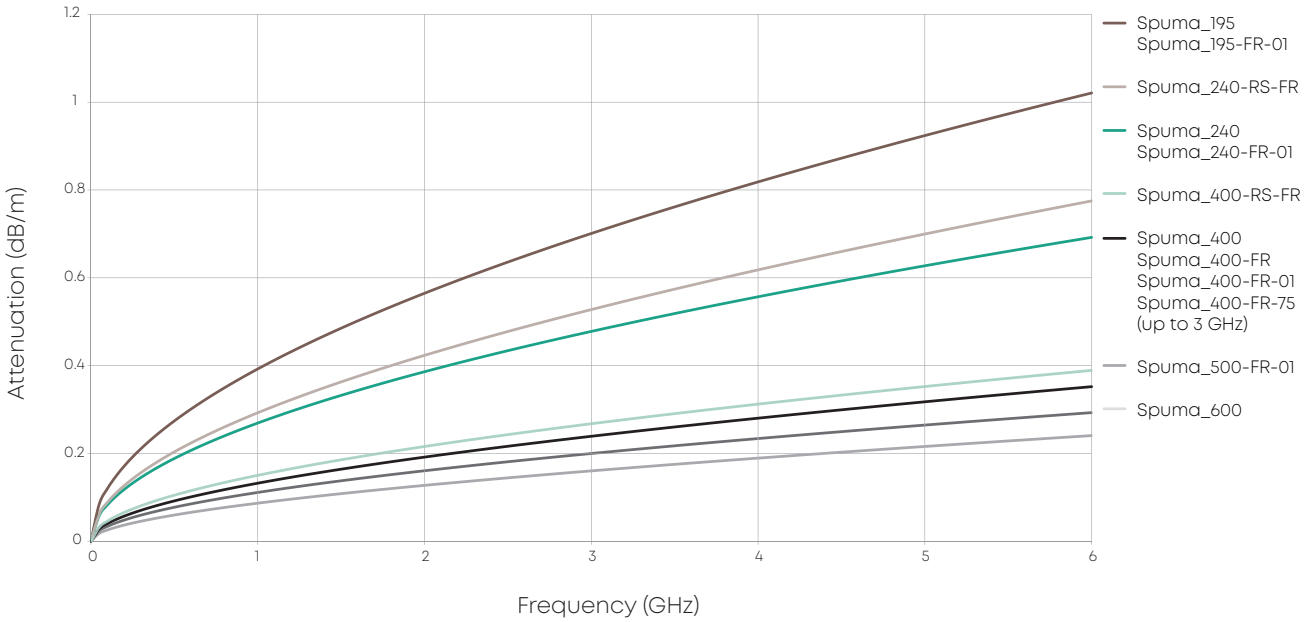

CW power

Max. values at 40 °C ambient temperature and sea level

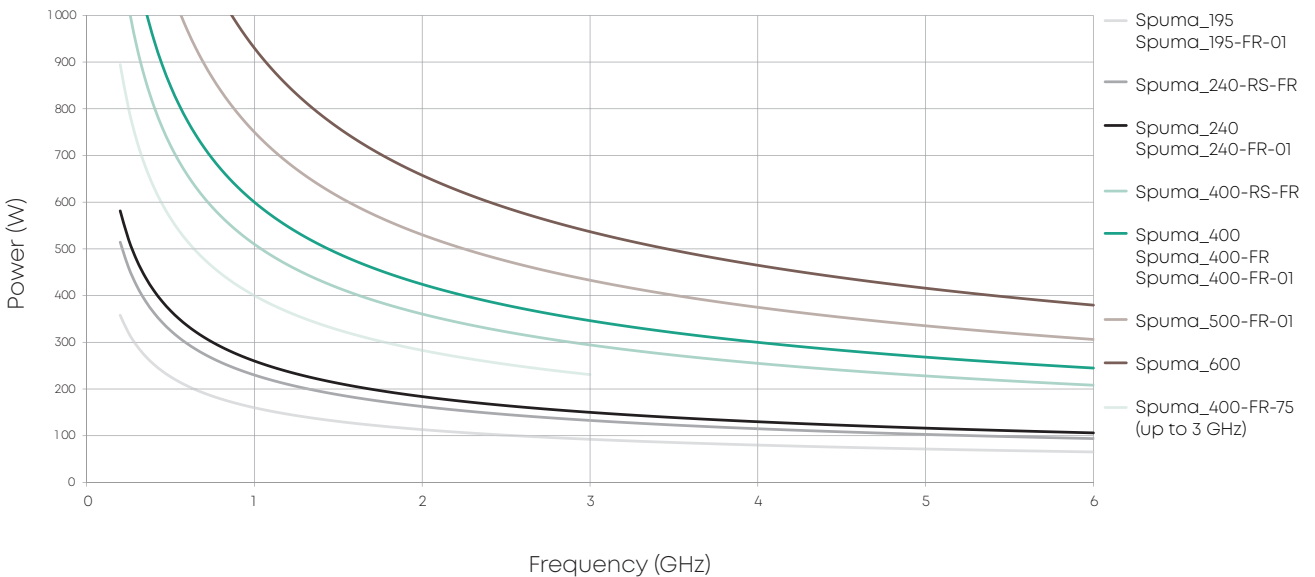

Spuma – portfolio overview



Spuma + Spuma FR



Spuma RS FR

		Spuma_195 84151727	Spuma_195-FR-01 85021562	Spuma_240 84151737	Spuma_240-FR-01 85021563	Spuma_240-RS-FR 85089188	Spuma_400 84102703	Spuma_400-FR-01* 84132035	Spuma_400-RS-FR 85089191	Spuma_500-FR-01 85021564	Spuma_600 84151738	Spuma_400-FR-75 85022187
--	--	-----------------------	-----------------------------	-----------------------	-----------------------------	-----------------------------	-----------------------	------------------------------	-----------------------------	-----------------------------	-----------------------	-----------------------------

Construction

		Spuma_195 84151727	Spuma_195-FR-01 85021562	Spuma_240 84151737	Spuma_240-FR-01 85021563	Spuma_240-RS-FR 85089188	Spuma_400 84102703	Spuma_400-FR-01* 84132035	Spuma_400-RS-FR 85089191	Spuma_500-FR-01 85021564	Spuma_600 84151738	Spuma_400-FR-75 85022187
1 Centre conductor	Cu wire
	Al/Cu wire					
	Cu low loss strand					.		.				
2 Dielectric	Foamed PE
3 Inner shield	Al-PES foil
4 Outer shield	Tin plated copper braid
5 Jacket	PE	
	LSFH	
	TPU					.		.				
	Diameter (mm)	4.95	4.98	6.15	6.17	6.17	10.3	10.3	10.3	12.8	15	10.3
Diameter (in)	0.195	0.196	0.242	0.243	0.243	0.404	0.404	0.404	0.503	0.590	0.404	

Electrical

Impedance	Ω	50 +/--2										75+/--3
Operating frequency	GHz	< 6										3
Screening effectiveness up to max. op. freq.	dB	> 90										
Attenuation at max. operating frequency	dB/m	1.02		0.69		0.78	0.35		0.39	0.29	0.24	0.25
	dB/ft	0.31		0.21		0.24	0.11		0.12	0.09	0.07	0.12
Power at 1 GHz , 40 °C ambient temperature	W	160		240		230	600		510	750	930	400

Mechanical

Bending static	mm	12.5	10	19	14	14	25	25	25	34	38	25
	in	0.49	0.39	0.75	0.55	0.55	0.98	0.98	0.98	1.34	1.50	0.98
Bending repeated	mm	50	40	60	53	53	100	100	100	130	152	100
	in	1.97	1.57	2.36	2.09	2.09	3.94	3.94	3.94	5.12	5.98	3.94

Environmental

Operating temperature	°C	-40 to +85										
Installation temperature	°C	-20 to +60										
Halogen free	
RoHS	2011/65/EC
CPR	EN 50575	Fca	Eca	Fca	B2ca	**	Fca	Cca	**	Eca	Fca	**
Railway approvals	EN 45545-2		HL3		HL3	HL2		HL3	HL2	HL3		HL3
	NFPA-130	

* UL recognized alternative available: Spuma_400-FR (84040210)

**To be tested on request

Spuma – connector overview

Cable type	Connector pattern	Connector								
		Spuma_195 Spuma_195-FR-01	Spuma_240 Spuma_240-FR-01	Spuma_240-RS-FR	Spuma_400 Spuma_400-FR Spuma_400-FR-01	Spuma_400-RS-FR	Spuma_500-FR-01	Spuma_600	Spuma_400-FR-75	
Cable group		X27	X28	X34	U30	X32	X31	X29	X33	
7/16	11		.		.			.		
	16				.	.				
	24				.					
BNC	11				
	16					
	21	.								
N	11	
	16	
	21	
QMA	11		.	.						
	16		.	.						
	21		.							
QN	11				
	16				
	24				
XQN	11		.	.						
SMA	11				
	16				
	21	.	.							
TNC	11				
	16				
	21	.	.							
	24	.	.							

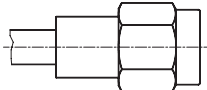
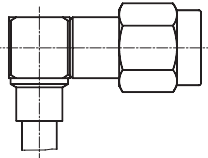
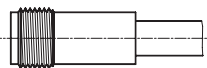
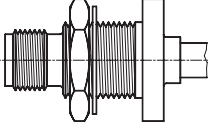
11	straight cable plug (male)	16	right angle cable plug (male)
			
21	straight cable jack (female)	24	straight panel bulkhead cable jack (female)
			



Detail view Spuma_400-RS-FR showing patented Rotary Swaging technology

RF-over-Fiber series

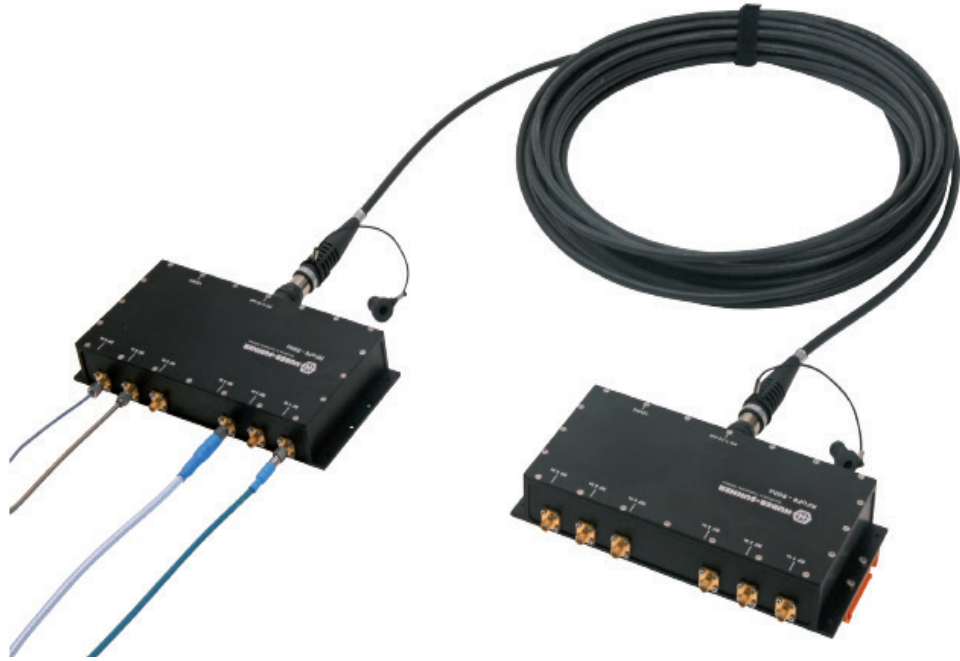

The market is evolving at a significant pace. With customers seeking to converge multiple technologies into a single solution, HUBER+SÜHNER has positioned itself to be able to provide customers with end-to-end hybrid solutions.

The RF-over-Fiber Series enables the use of radio frequency and fiber optics in a single connectivity link. With these two core technologies, HUBER+SÜHNER is using its vast experience and expertise to deliver best-in-class opto-electronic technology to the market.

The RF-over-Fiber Series consists of three core product lines, namely; RF-over-Fiber (RFoF), GPS-over-Fiber (GPSoF) and LAN-over-Fiber (LANoF).

The main advantages that RF-over-Fiber links have over traditional RF links are that they:

- allow for greater distances between the RF source and the RF receiver system
- are immune to EMI and RFI
- are immune to EMP
- are more difficult to intercept („tap“)
- are lighter in weight

System components

RF-over-Fiber (RFoF)

- 100 KHz to 40 GHz
- Low noise options and duplex systems
- Simplex and duplex systems
- Fully configurable

GPS-over-Fiber (GPSoF)

- L1 and L2 bands
- Covers all major GNSS services
- Multipoint receivers
- 1 PPS and 10 MHz

LAN-over-Fiber (LANoF)

- Gigabit connectivity
- Fully configurable

Applications

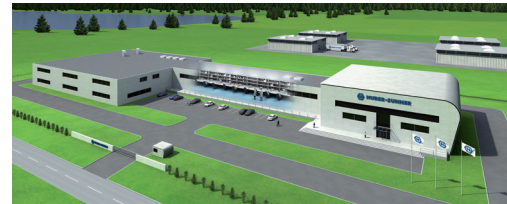
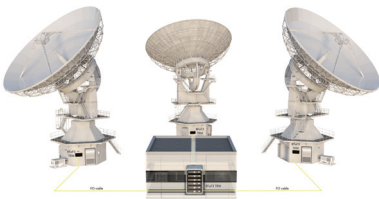

SATCOM

In SATCOM applications, RF-over-Fiber enables communication between satellites and control centers. The communication link is created by connecting the antenna to the control center. RF-over-Fiber supports both fixed earth installations as well as mobile applications.

Test environments

RF-over-Fiber is ideal for test environments due to its immunity to RF and EM interferences. With frequency ranges up to 40 GHz, RF-over-Fiber delivers value-adding performance in sensitive environments. A perfect choice for TVAC environments due to the small cable footprint and interconnect panel footprints that facilitate high-density (1:n DUT) testing. RF-over-Fiber links > 100 GHz currently in development.

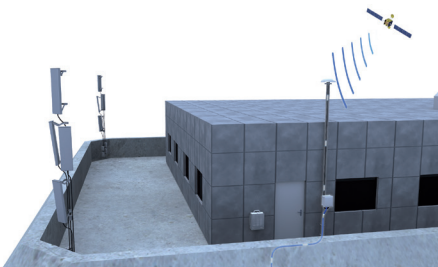

Timing distribution

The distribution of precise time and reference signals is growing rapidly in its utility within the space industry. Whether GPS-based or OXCO oscillator-driven 1PPS/10 MHz signal distribution, HUBER+SUHNER has a comprehensive portfolio of timing products and capabilities.

Airborne

High density RF connectivity with a significantly reduced cable footprint is key to the success of the HUBER+SUHNER airframe solution. Weight reduction and cost optimization are achieved by using less material as well as speeding up the installation and maintenance processes. Ideal for aircraft, UAV's, aerostat and other airborne applications.

RF-over-Fiber

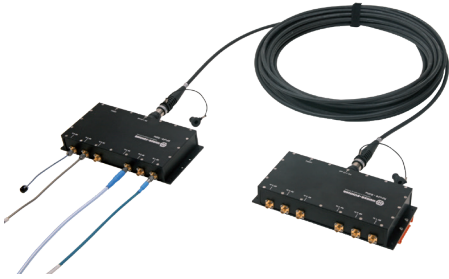

Driven by a philosophy of providing high density RF connectivity, while significantly reducing cable footprints. HUBER+SUHNER's single mode, simplex and duplex systems are both flexible and perfect for harsh environments. Flexibility is achieved by providing customers with a wide range of options when it comes to inter-connectivity, while the scalability of the systems enables an unlimited RF connectivity density.

The use of HUBER+SUHNER's renowned components, such as RADOX and Q-ODC-12, ensures that the system can be deployed in any environment and with a significantly smaller cable footprint.

The standard RFoF modules are available in 1, 6 and 12 ports and cover a wide frequency range of 100 KHz to 40 GHz. The systems are capable of covering distances of up to 100 km and are perfect for applications requiring secure, low loss, light-weight and high-density connectivity.

RF-over-Fiber		# of RF ports				Key technical parameters/features									
Item	Item description	1	3	6	12	Simplex	Duplex	Frequency MHz		Gain flatness* dB/100 MHz	Noise figure* dB	SFDR* dB Hz ^{2/3}	OIP3* dBm	Single-mode	Max. link distance** km
								from	to						
85073881	RFoF1 – 3 GHz (TX)	•				•		1	3000	< 1.5	15	100	20	•	100
85073882	RFoF1 – 3 GHz (RX)	•				•		1	3000	< 1.5	15	100	20	•	100
85073883	RFoF1 – 3 GHz (TRM)	•				•		1	3000	< 1.5	15	100	20	•	100
85071061	RFoF6 – 3 GHz (TX)			•		•		1	3000	< 1.5	15	100	20	•	100
85071062	RFoF6 – 3 GHz (RX)			•		•		1	3000	< 1.5	15	100	20	•	100
85071063	RFoF12 – 3 GHz (TX)				•	•		1	3000	< 1.5	15	100	20	•	100
85071064	RFoF12 – 3 GHz (RX)				•	•		1	3000	< 1.5	15	100	20	•	100
85071065	RFoF3 – 3 GHz (TRM)		•			•		1	3000	< 1.5	15	100	20	•	100
85071066	RFoF6 – 3 GHz (TRM)			•		•		1	3000	< 1.5	15	100	20	•	100
85065392	RFoF6 – 6 GHz (TX)			•		•		300	6000	< 1.5	20	100	10	•	100
85065393	RFoF6 – 6 GHz (RX)			•		•		300	6000	< 1.5	20	100	10	•	100
85074581	RFoF6 – 6 GHz LN (TX)			•		•		300	6000	< 0.7	7	105	10	•	100
85074578	RFoF6 – 6 GHz LN (RX)			•		•		300	6000	< 0.7	7	105	10	•	100
85065394	RFoF12 – 6 GHz (TX)				•	•		300	6000	< 1.5	20	100	10	•	100
85065395	RFoF12 – 6 GHz (RX)				•	•		300	6000	< 1.5	20	100	10	•	100
85071630	RFoF3 – 6 GHz (TRM)		•			•		300	6000	< 1.5	20	100	10	•	100
85071631	RFoF6 – 6 GHz (TRM)			•		•		300	6000	< 1.5	20	100	10	•	100
85072903	RFoF1 – 20 GHz (TX)	•				•		200	20 000	< 1.0	45	100	28	•	100
85072904	RFoF1 – 20 GHz (RX)	•				•		200	20 000	< 1.0	45	100	28	•	100
85076291	RFoF1 – 20 GHz (TRM)	•				•		200	20 000	< 1.0	45	100	28	•	100
85077808	RFoF1 – 20 GHz LN (TX)	•				•		200	20 000	< 1.0	8	105	25	•	100
85077809	RFoF1 – 20 GHz LN (RX)	•				•		200	20 000	< 1.0	8	105	25	•	100

* Typical value(s)

** Real link distances are dependent on the application/environment.

Datasheet RFoF6 – 3 GHz

Electrical data		Value			Remarks
		minimal	typical	maximal	
Frequency range	MHz	1		3000	3 dB bandwidth
Gain	dB	6	10	14	
Gain flatness	dB/100 MHz		< 1.5		
Noise figure	dB	12	15	25	
Spurious-free dynamic range	dB Hz ^{2/3}		100		
Max. input at 1dB compression	dBm		+0		
Max. input power for no damage	dBm		+15		
VSWR (input and output)	dB		< 1.8		
OIP3	dBm		+20		
Time delay	Ns		12		
Supply voltage transmitter	VDC	+11	+12	+16	max. 750 mA
Supply voltage receiver	VDC	+11	+12	+16	max. 500 mA
Temperature range	operating storage	°C °C	-40 -40	+85 +85	
RF input impedance	Ω	50			

Optical Data		Value			Remarks
		minimal	typical	maximal	
Fiber optic connectors		Q-ODC 12			
Fiber		Single mode fiber 9/125 um			
Fiber power loss	dB/km		0.4		
Optical power in fiber	mW	3	6	10	
Side mode suppression ratio	dB	30	40		

Mechanical Data		Value	Remarks
Module weight	kg	1.1	transmitter and receiver
Module dimensions	mm	220 × 100 × 34	transmitter and receiver
RF connectors		QMA/SMA female	

All specifications at 25 °C case temperature Tc, unless otherwise specified.

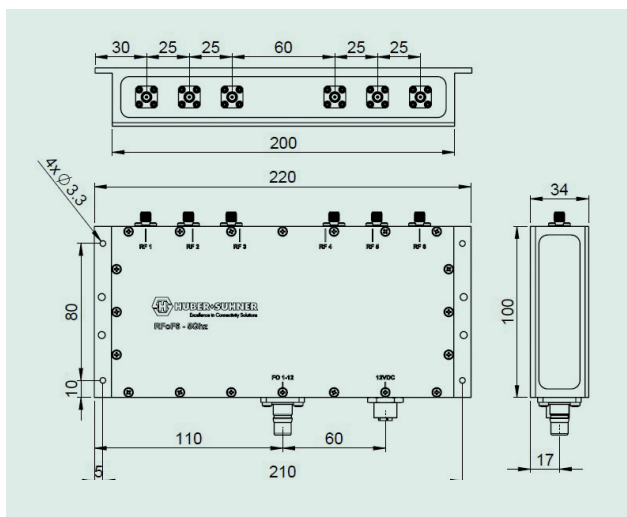

RF-over-Fiber RFoF4+WDM – 22 GHz LN (TRM)

The Multiplexed RF-over-Fiber Transceiver Module [RFoF4+WDM–22 GHz LN (TRM)] is a bi-directional, multi-channel solution that converts analog RF signals into fiber signals; and then converts the fiber signals back into RF signals. The module multiplexes 8 channels onto a single fiber using our state-of-the-art WDM technology. The module offers a wide frequency range up to 22 GHz, with very low noise, excellent all-round link stability and performance.

Features

- Integrated WDM
- Extremely low noise figure
- Wide bandwidth from 1 GHz to 22 GHz
- Flexible form factor options

Applications

- Defence applications
- Test environments

Order information

Item description	Item no.
RFoF4+WDM – 22 GHz LN (TRM)	85109690
RFoF4+WDM – 22 GHz LN (TRM) [M]	85117566

Additional Information

- All modules are RoHS compliant.
- All modules are EMC protected.
- DIN 35 brackets are delivered with each module. Other brackets available upon request.
- MIL and other certifications are possible upon request.
- Various racks and enclosures available.

Datasheet RFoF4+WDM – 22 GHz LN (TRM)

Electrical data		Value			Remarks
		minimal	typical	maximal	
Frequency range 1 22	GHz	1		22	
Gain	dB	8		15	
Gain flatness	dB/GHz		1		4 between 1 GHz and 2 GHz
Noise figure	dB	5.5	7	14	< 8 up to 15 GHz
Spurious-free dynamic range	dB Hz ^{2/3}				
Max. input at 1 dB compression	dBm		-35		
Max. input power for no damage	dBm		-25		
Input return loss	dB		> 7		
OIP3	dBm		-20		
Supply voltage – transmitter	VDC	+11	+12	+15	500 mA
Supply voltage – receiver	VDC	+11	+12	+15	200 mA
Temperature range (OTR) operating storage	°C	-20		+60	
	°C	-55		+85	
Isolation	dB		> 60		between channels
RF input impedance	Ω	50			
RF connectors		SK female			alternative connectors possible

Optical data		Value			Remarks
		minimal	typical	maximal	
Fiber optic connectors		FC/APC			alternative connectors possible
Fiber		single mode fiber 9/125 um			
Wavelength	nm		1550		
Optical power in fiber	mW	1	3	6	
Side mode suppression ratio	dB	30	40		

Mechanical data		Value			Remarks
		minimal	typical	maximal	
Module weight	kg	2.70			
Module dimensions	mm	482.6 × 286 × 43.65 260 × 180 × 85			chassis version module version

All specifications at 25 °C case temperature Tc, unless otherwise specified.

GPS-over-Fiber (GPSoF)

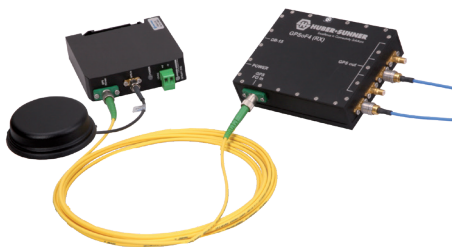

Our GPSoF modules are focused on distributing a single GPS signal into multiple receiver systems. This approach ensures that signal data, such as time synchronization into separate, yet connected, systems is always the same. Standard GPSoF systems include both single and multiport solutions; and accommodate both L1 and L2 bands.

In addition to the GPSoF modules, HUBER+SUHNER also provides a Time and Frequency Standard (TFS) module. This module uses 1PPS to ensure that time synchronization is still possible in the event of a loss of GPS signal. The pulse is synchronized to the average of the GPS signal. The module also provides a 10 MHz electrical output, which is used for reference signaling. The small form factor of the GPSoF modules ensures that the systems are ideal for both fixed and mobile applications, where space may be limited.

GPS-over-Fiber		# of RF ports		Key technical parameters/features										
Item	Item description	1	4	Simplex	Frequency MHz		Gain flatness*	Noise figure*	SFDR*	OIP3*	1PPS	10 MHz	Single-mode	Max. link distance**
					from	to	dB/100 MHz	dB	dB Hz ^{2/3}	dBm				km
85065409	GPSoF1 – 1.5 GHz (TX)	.	.	.	1565	1615	< 2.0	14	100	7	.	.	.	100
85065397	GPSoF1 – 1.5 GHz (RX)	.	.	.	1565	1615	< 2.0	14	100	7	.	.	.	100
85065809	GPSoF4 – 1.5 GHz (RX)	.	.	.	1565	1615	< 2.0	14	100	7	.	.	.	100
85072905	GPSoF1 – 1.5 GHz (TX) L1+L2	.	.	.	1218	1615	< 2.0	14	100	7	.	.	.	100
85072906	GPSoF1 – 1.5 GHz (RX) L1+L2	.	.	.	1218	1615	< 2.0	14	100	7	.	.	.	100
85072907	GPSoF4 – 1.5 GHz (RX) L1+L2	.	.	.	1218	1615	< 2.0	14	100	7	.	.	.	100
85072918	TFS1.10	.	.	.	1218	1615	N/A	N/A	N/A	N/A	.	.	.	100
85072919	GPSoF4+ (RX)	.	.	.	1218	1615	<2.0	14	100	7	.	.	.	100

* Typical value(s)

** Real link distances are dependent on the application/environment.

Datasheet GPSoF – 1.5 GHz (L1+L2)

Electrical data		Value			Remarks
		minimal	typical	maximal	
Frequency range	MHz	1218		1615	
Gain	dB	4	7	10	
Gain flatness	dB/100 MHz		< 2		
Noise figure	dB		14		
Spurious-free dynamic range	dB Hz ^{2/3}		100		
Max. input at 1dB compression	dBm		-20		
Max. input power for no damage	dBm		+15		
VSWR (input and output)	dB		< 1.8		
OIP3	dBm		+ 7		
Time Delay	Ns		55		
Supply voltage Vs transmitter	VDC	+12	+12	+15	max. 170 mA
Supply voltage Vs receiver	VDC	+12	+12	+15	max. 100 mA
Temperature range	operating	°C	-40	+85	
	storage	°C	-40	+85	
RF input impedance	Ω	50			

Optical data		Value			Remarks
		minimal	typical	maximal	
Fiber optic connectors		FC/APC			
Fiber		Single mode fiber 9/125 um			
Optical power in fiber	mW	6	8	10	
Side mode suppression ratio	dB	30	40		

Mechanical data		Value			Remarks
		minimal	typical	maximal	
Module weight	g	270			transmitter and receiver
Module dimensions	mm	90 × 95 × 23			transmitter and receiver
RF connectors		QMA/SMA female			

All specifications at 25 °C case temperature Tc, unless otherwise specified

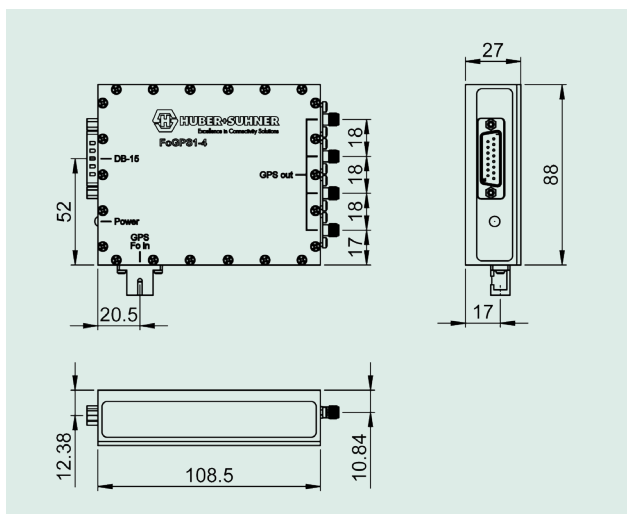

LAN-over-Fiber



With the use of multimedia continuing to increase within the operations landscape (from planning to de-briefing), our modules are focused on providing Gigabit connectivity within challenging environments.

Again, the use of HUBER+SUHNER's RADOX and Q-ODC-12 components ensure that the exposed portions of the system remain functional within harsh environments, while the interconnect within a mobile structure (shelter or vehicle) remains robust and functional within environments exposed to, for example, intense vibration.

The standard LANAoF modules are available in 1, 6 and 12 ports and can be easily integrated into existing network infrastructures. The LANAoF system is particularly well suited to applications that require "field LAN" capabilities for data synchronization, diagnostics, remote identification and software distribution.

LAN-over-Fiber		# of LAN ports			Key technical parameters/features				
Item	Item description	1	6	12	Duplex	Bit rate		Single mode	Max. link distance**
						from	to		
						Mbps	Mbps		
85072917	LANoF1 – 1 Gbps	.			.	10	1000	.	20
85065410	LANoF6 – 1 Gbps		.		.	10	1000	.	20
85065411	LANoF12 – 1 Gbps			.	.	10	1000	.	20

** Real link distances are dependent on the application/environment.

Datasheet: LANoF6 – 1 Gbps

Electrical data		Value			Remarks
		minimal	typical	maximal	
Data rate	Mbps	10		1000	
Max. distance	km			20	
Max. optical input power for no damage	dBm		+15		
Supply voltage Vs	VDC	+12	+12	+32	max. 100 mA
Temperature range	operating storage	°C °C	0 -40	+70 +85	

Optical data		Value			Remarks
		minimal	typical	maximal	
Fiber optic connectors		Q-ODC-12			
Fiber		Single mode fiber 9/125 um			
Fiber power loss	dB/km		0.4		
Optical power in fiber	mW	3	6	10	
Side mode suppression ratio	dB	30	40		

Mechanical data		Value			Remarks
		minimal	typical	maximal	
Module weight	kg	1.3			transmitter and receiver
Module dimensions	mm	270 × 150 × 90			transmitter and receiver
LAN connectors		RJ45/M12 P4			

All specifications at 25 °C case temperature Tc, unless otherwise specified

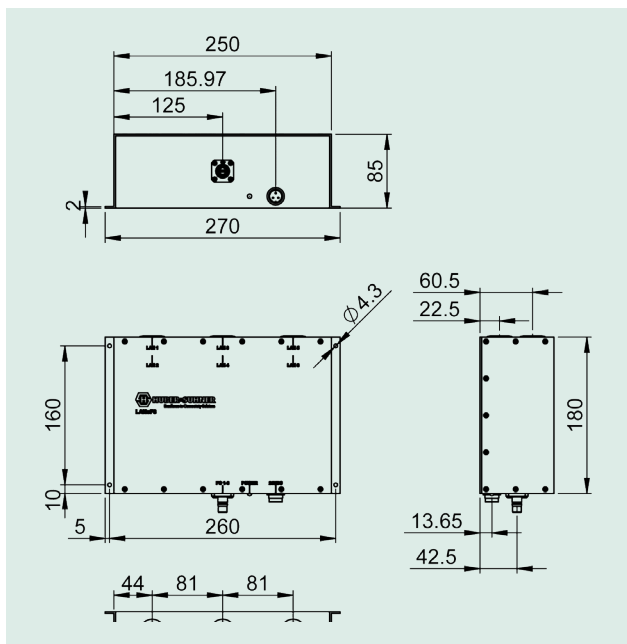

Customized modules

The modular design of the RF-over-Fiber series products ensures that HUBER+SUHNER is able to provide fast, flexible and cost-effective customizations that meet our customers' application requirements.

Customized options include

- Small-form-factor for applications that have limited space available
- Housings that support the light-weighting requirements of an application
- A combination of RF, GPS and LAN functionality into a single module
- Ruggedization for use in harsh environments (i.e. extreme temperatures, vibration and shock)
- High-density housings for applications that need to limit the amount of hardware within the solution without compromising on connectivity density
- Customer-specific interconnect options (for both RF and FO)
- Rack-mountable housings

Small-form-factor

- Housings that support the light-weighting requirements of an application
- Small-form-factor for applications that have limited space available

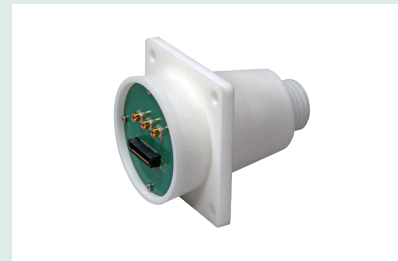

Combined technologies

- Rack-mountable housings
- A combination of RF, GPS and LAN functionality into a single module



Ruggedized enclosures

- Rack-mountable and high-density housings
- Ruggedization for use in harsh environments (i.e. extreme temperatures, vibration and shock)



Key application: SATCOM

(Makes use of RFoF and LANoF)

In SATCOM applications, RF-over-Fiber enables communication between satellites and control centers. The communication link is created by connecting the antenna to the control center. RF-over-Fiber supports both fixed earth installations as well as mobile applications.

Broad frequency ranges, excellent performance and security are critical aspects that are perfectly addressed by HUBER+SUHNER's RF-over-Fiber products. With single modules that cover the all intermediate frequency (IF) signals as well as the L, S and C bands, HUBER+SUHNER not only meets the frequency range requirements in SATCOM, but also has low noise modules in its portfolio that can be used in noise-sensitive applications. The low noise modules offer a 50 % lower noise figure, from 15 dB to 7 dB (IF signals).

Excellent performance and the security of the SATCOM links are further supported by immunity to EMI, RFI and EMP.

The use of LAN-over-Fiber is growing within the SATCOM applications landscape. Ethernet connectivity for VOIP, VPN connectivity and other data network services are easily integrated into both fixed and mobile infrastructures. Gigabit LAN modules ensure the future-proofing of all SATCOM applications.

Key benefits

- Security Immune to EMI and RFI. Lower risk of interception.
- Better performance Greater distances covered, immune to EMP and very low loss.
- Mobility Less cable and weight supports rapid deployment in mobile applications.
- Efficient Faster and simplified installation and maintenance (key in mobile applications – SNG and VSAT)

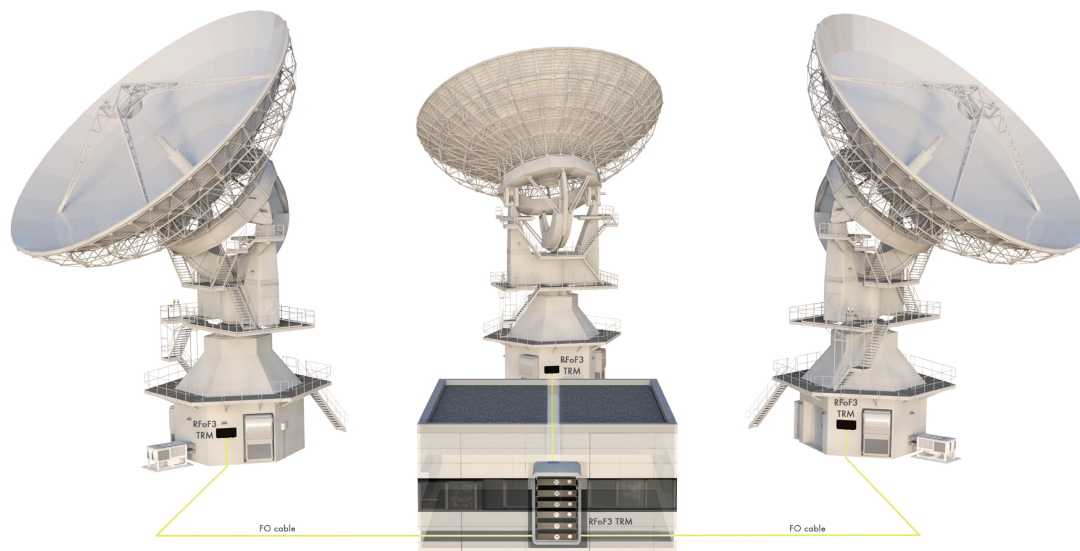

Solutions business



Products

With the market rapidly moving to **combine technologies and to increase connectivity density**, our growing system product portfolios provide the bridges for the delivery of end-to-end solutions.

Services

HUBER+SUHNER's **global supply chain network and engineering footprint** enables us to provide our customers with a one-stop-stop for their service needs. Our servicing offering includes kitting, painted antennas, sourcing, project management and other value-adding services.

Sub-systems

Excellence in engineering and manufacturing provides the basis for delivering added value to our customers within the sub-systems area. HUBER+SUHNER **is perfectly positioned to deliver hybrid, multi-product and build-to-print solutions**.

End-to-end connectivity solutions

The nature of systems developments and Implementations requires global **project excellence** along with a focus on delivering solutions instead of components. Our **turn-key solution approach** (which combines project management, solution design capabilities and high performing products) is a key differentiator in this fast-growing area of our business.

Solutions – examples

Cable solutions

With radio frequency, low frequency and fiber optic technologies all core competencies of HUBER+SUHNER, we are able to provide a host of harnessing and hybrid assembly cable solutions.



Bespoke componentry

Project-specific componentry forms a significant part of the HUBER+SUHNER value proposition. Our Metalized Additive Manufacturing capabilities, in particular, is generating a lot of interest in the filter, diplexing, antenna, and space-flight waveguide space.

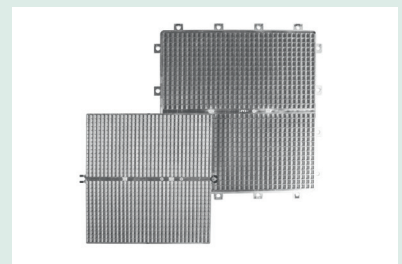

Box builds/mechanical integration

Mechanical integration is a key part of applications that have limited space and that are built into customer-specific sub-systems. HUBER+SUHNER's box build offers additional value by streamlining the integration process, while ensuring superior quality and performance.



End-to-end connectivity solutions

Command and control centers require a host of space-grade RF components. HUBER+SUHNER's space portfolio covers all of the products required for an end-to-end connectivity solution. These include connectors, EMPs, antennas, cable assemblies as well as a host of interface panes, racks and junction boxes.



Polatis optical switching solutions

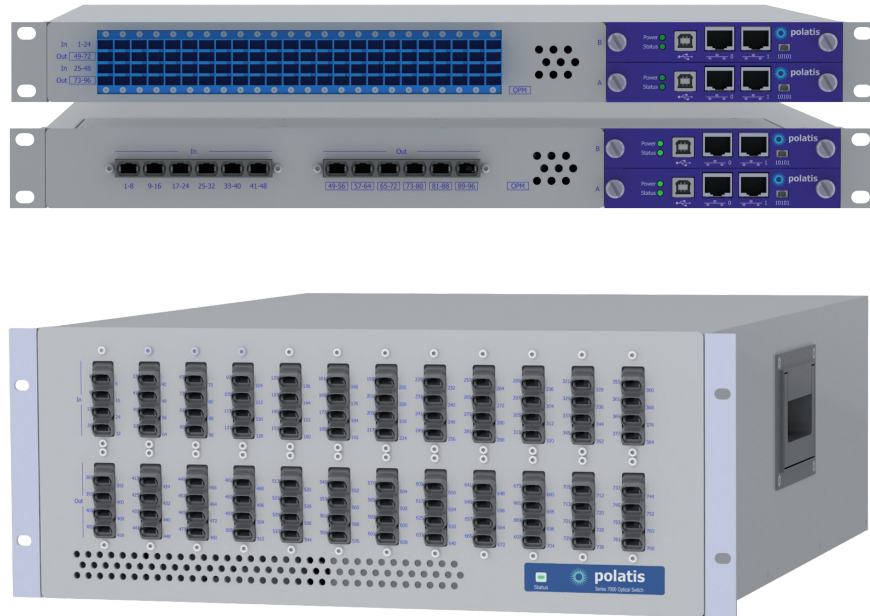

HUBER+SUHNER Polatis is the leading provider of all-optical switches, enabling low latency, fully transparent connections between optical fibers without requiring conversion between optical and electrical signals to offer much greater flexibility and energy efficiency. The patented DirectLight® optical switch technology connects fibers with the best possible optical performance. The modular, strictly non-blocking optical switch platform scales from 4x4 to 384x384 ports, applying class-leading performance to provide dynamic connectivity for today's network services.

Polatis all-optical switches are time proven in mission-critical network applications, with key features that enable operators and systems integrators to deliver secure, scalable, reliable, manageable and cost-effective optical cross-connect capabilities.

Polatis Optical Switching Solutions

SDN-enabled all-optical switch

Embedded OpenFlow and NETCONF interfaces enable a faster deployment of new software-defined network solutions.

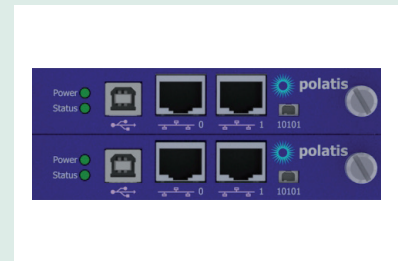

Industry leading port density

Broadest portfolio available on the market from 4x4 up to 384x384 fiber ports per switch, also available in asymmetric (MxN) and reconfigurable (M-fiber) configurations.



Adds flexibility to today's network services

Automated fiber provisioning, protection, monitoring, reconfiguration and test applications.

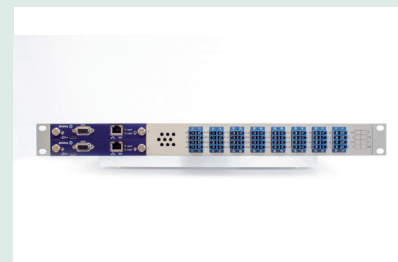

Transparent connectivity and superior performance

Low optical loss and dark fiber switching enables dynamic, bandwidth-agnostic network architectures with minimal system impact and near-zero latency.



Proven track record

The reliable, field-proven DirectLight™ optical switch technology powers more than 2000 systems worldwide.

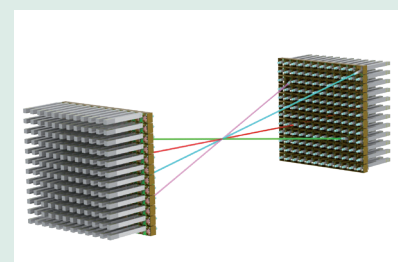

The Potential of All-Optical Switching

Network operators are searching for bandwidth-on-demand capabilities that allow them to direct network capacity where and when it is needed, with performance guarantees to support latency, jitter and availability requirements for a range of diverse applications. Adoption of dynamic fiber cross-connects to bring the physical layer under software control allows rapid provisioning, protection and reconfiguration of network resources on-demand bringing additional benefits to operators, including:

- Eliminating manual patch errors and the potential for service interruption
- Maintaining current state of physical layer connectivity in a software database
- Creating optical demarcation points in multi-tenant/multi-service provider environments
- Facilitating bridge and roll during equipment commissioning, upgrade and replacement
- Providing physical isolation between virtualized network slices for enhanced security
- Enabling aggregation of optical taps for network monitoring
- Automated protection services for individual or groups of traffic lines

Since all-optical circuit switches do not require any optical-to-electrical conversions, they consume very little energy and add virtually no latency to the data path. Connections are fully transparent and format independent, which makes them ideal for use in network infrastructures where optical transmission rates continually advance.

While individual optical circuit switches can provide up to a few hundred ports of non-blocking connectivity, scaling beyond this level is only possible using multi-stage cross-connect fabrics. These multi-stage fabrics operate within the restricted power budgets of lowcost optical transceivers due to the very low loss characteristics of the Directlight® technology.

SDN-ENABLED All-Optical Switching

Today's Three-Tiered Network Architectures

SDN-enabled all-optical switching is being introduced at a number of levels to optimize network resources in today's network services, alongside existing packet routers and switches. In the application outlined below, all-optical switching is not a replacement for packet switching; it is added to the existing network to bring the capacity, flexibility and scalability needed at key congestion points to meet heavy and persistent traffic demands.

Large networks have clusters of tens of thousands of servers distributed across rooms, buildings and campuses. To provide reliable and scalable interconnections between all of these servers, networks are typically built in tiers using a combination of packet routers and circuit switches at the core/metro, aggregation and access levels. This hierarchy enables efficient sharing of data and provides services across internal networks while also connecting to the outside. All-optical switching can be added to each tier of the network to enhance performance and reduce costs. Graphic 1 shows the basic tiered approach including potential locations for all-optical switching in each tier.

The Potential of All-Optical Switching

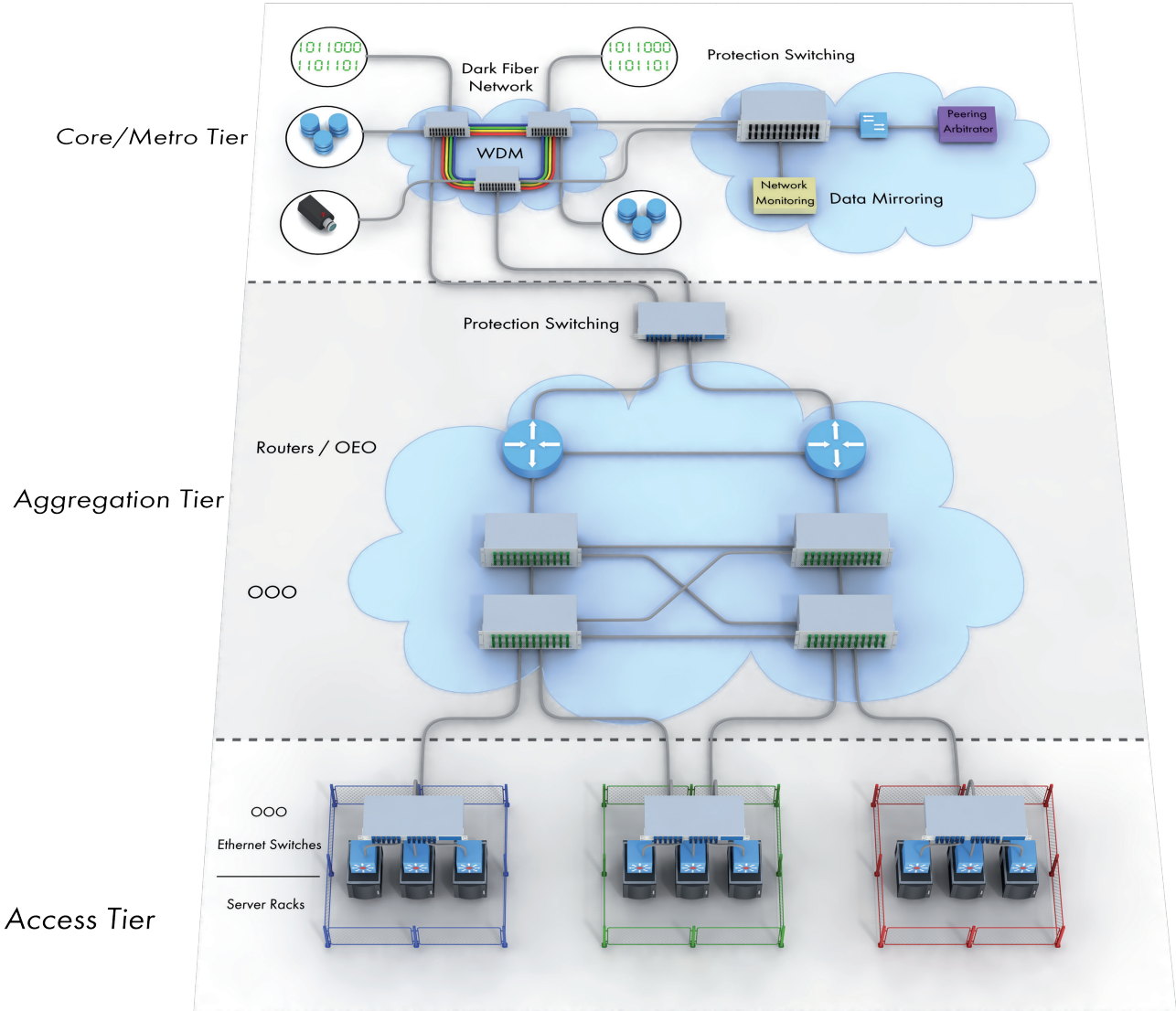

Graphic 1

Technology

- DirectLight® free-space optical switch technology connects fibers with the best possible optical performance
- Patented 2D piezo beam-steering with integrated position control
- Lowest loss all-optical cross-connect – typical 1 dB IL
- Modular platform scales from 4x4 thru 384x384
- Available in dual-sided symmet e-sided (M-fiber) variants
- True transparent dark-fiber switch connections are independent of protocol, bitrate, light color, direction or power level
- Optical power monitoring enables Variable Optical Attenuation (VOA) and Automatic Protection Switching (APS) functionality

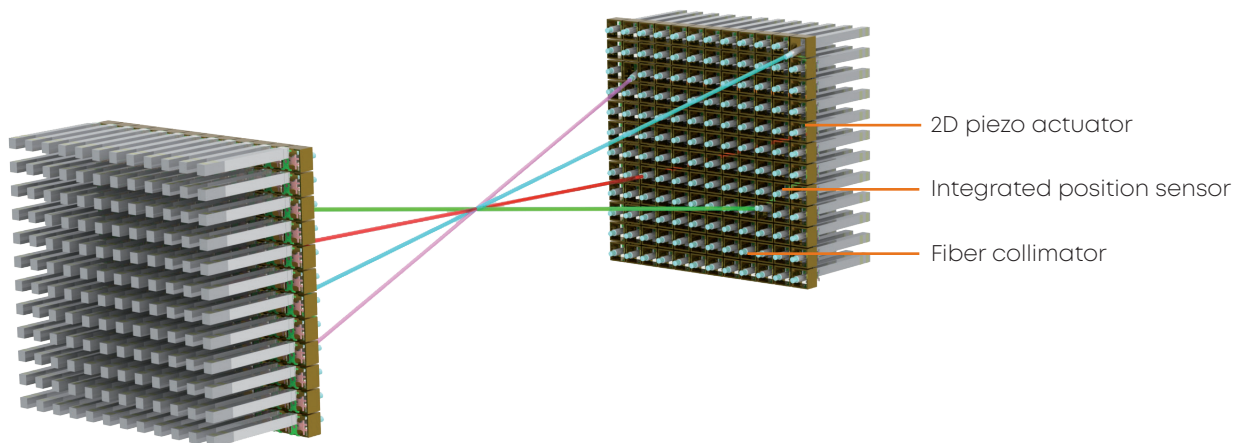

Products

Series	Matrix size	Technology	Optional functions	Key features
3000	4x4 to 16x16	DirectLight™ multimode		World's only multimode fiber matrix switch Supports OM1 and OM3/OM4 fibers Available in N×N, M×N configurations
6000	4x4 to 192x192	DirectLight™ single mode	OPM APS VOA	Low insertion loss / superior optical specs Carrier class interfaces (SNMP, TL1, etc.) Available in NxN and MxN configurations Single sided N-fiber variants available SDN enabled with OpenFlow and NETCONF
6000 PSS	4, 8 or 16 Rx/Tx line pairs protection services	DirectLight™ single mode		Compact 1+1 optical layer protection Up to 16 services in 1U, < 25 watts Pre-configured, drop in APS system Automatic LOS protection and restoration
7000	208x208 to 384x384	DirectLight™ single mode	OPM APS VOA	Superior optical specs N×N and M×N configurations SDN enabled carrier-class interfaces Low power, resilient architecture

OPM – optical power monitor
 APS – automatic protection switching
 VOA – variable optical attenuation

Kommentar R. Buff, 20.8.2020 - The complete CWDM section is missing. We mentioned it only on the Sat-com overview page. We will need to add this section once you're back from your vacation Michele.



HEMP and lightning protection



Four decades of experience in developing and manufacturing coaxial- and data line-HEMP and LEMP protectors are the foundation of our current EMP protector portfolio and have made HUBER+SUHNER a first stop for protection solutions in defense applications. HUBER+SUHNER offers protection components for land- based, airborne and naval tactical communications as well as for navigation, radar and electronic warfare applications.

Our products are designed to meet the stringent requirements of the defense and security markets. An extensive high-voltage impulse laboratory is available to verify our designs in accordance with the valid lightning, surge and HEMP standards.

HUBER+SUHNER holds groundbreaking patents in the field of coaxial lightning and HEMP protection, such as the automatically suppressing surge arrester (Semper). Many of our products are referenced by the NATO Maintenance and Supply Agency (NAMSA).

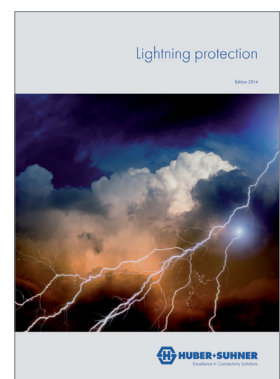

Lightning protection

Classified into following series

- Standard quarter-wave shorted stub protector „series 3400“
- Quarter-wave shorted stub protectors with high-pass filter „series 3407“



- Standard gas discharge tube (GDT) protectors „series 3401 and 3402“
- Gas discharge tube (GDT) protectors with high pass filter „series 3408“



- Self-extinguishing gas capsule protector (GDT) „Semper“



- High power/low PIM gas discharge tube protectors (GDT) „series 3409“



- Hybrid fine protectors „series 3403“



- Miniature and slim line gas discharge tube protectors (GDT) „series 3406“



- High RF power limiter „series 9078“



- Twisted pair data line protectors Cat5 and Cat6 „series 3414“



Lightning protection – product overview

Gas discharge tube protectors with exchangeable GDTs

- „Series 3401/3402“ (standard versions)
- For applications with RF and DC components on the antenna line the standard GDT lightning/EMP protectors feature DC continuity and large bandwidth. Most HUBER+SUHNER GDT protector designs provide excellent performance in the NEMP application as well. For specific applications internally DC-blocked GDT protectors are available.



Self-extinguishing GDT protectors (Semper)

The HUBER+SUHNER Semper design guarantees safe extinguishing of the GDT under high RF power or with additional DC components on the antenna line. By retrofitting standard GDTs with the Semper GDT existing installations can be upgraded. The Semper technology is a true improvement to the standard gas tube technology and increases reliability and lifetime of GDT protectors.



True broadband GDT protectors

- „Series 3406“
- SlimLine GDT protectors feature high return loss in the frequency band between DC and 6 GHz. This design is best suited for point to point and WLAN equipment.



Hybrid/low PIM/high power GDT protectors

- „Series „Series 3409“
- This patented technology features low passive intermodulation at extremely high continuous and peak instantaneous power (up to 25 kW PIP).



Bias-T/DC injectors with integrated lightning protector

- „Series 3410“
- Bias-T's, used to „feed-in“ or „pick-off“ DC voltage into or from antenna feeder cables, provide the operating voltage for active electronics installed on the mast (mast head amplifiers, etc.)



Hybrid GDT fine protectors

- „Series 3403“
- For very sensitive DC powered receivers such as those used in GPS installations, the hybrid GDT fine protectors with integrated transient voltage suppressor diodes guarantee lowest residual pulse energy. HUBER+SUHNER fine protectors feature DC continuity.



Lightning protection – product overview

Quarter-wave shorting stub protectors

- „Series 3400“
- HUBER+SUHNER quarter-wave shorting stub protectors perform best lightning parameters with excellent RF specifications within limited bandwidth. A ratio of 4:1 between lowest and highest frequency of the frequency band is achievable by still meeting high return loss. For specific applications internally DC-blocked quarter-wave shorting stub protectors are also available.



Filter protectors

- „Series 3407“
- LC or LCL band pass filter technologies allow an increase in bandwidth to ratios larger than 4:1 in a compact mechanical design, hence they are an alternative to quarter-wave shorting stub protectors. LC or LCL filter protectors are internally DC-blocked.



Data line protectors

- „Series 3414“ (twisted pair, ethernet)
- Our CAT 5 and CAT6 (Gigabit)data line protectors are „Power Over Ethernet“ compatible and available as IP68 rated robust components for outdoor applications (i.e. backhaul microwave links) or in IP20 specified housings for indoor installations (i.e. data processing centers).



Semper – self-extinguishing gas discharge tube protector



The patented Semper™ concept enhances the safety and reliability of the well-known gas discharge tube (GDT) protector principle impressively. It eliminates the risk of gas discharge tube "hold on" due to DC line powering or high RF signals which will render the system inoperable and can destroy the GDT. The Semper™ invention is based on a mechanical resettable thermo-switch which is integrated within the GDT protectors capsule holder.

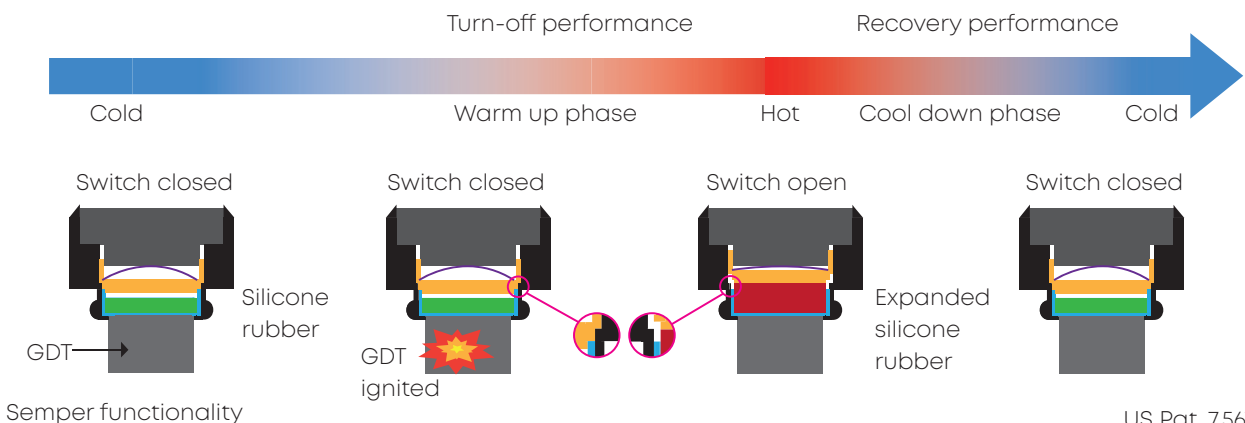

Gas discharge tube (GDT) protectors

This technology features bandwidths from DC – 6 GHz and can handle surge currents up to 30kA. GDT technology allows DC voltage on the center conductor. By selecting the correct GDT these products can be used in applications with transmit power up to 1 kW CW. For applications with higher power please consult the factory. A special version of this technology is represented by the self-extinguishing GDT protector (Semper). GDT technology provides reliable protection against natural and man-made surges.

Picture	HUBER+SUHNER type	Freq. range (MHz)	Connectors	Mounting	RL min. (dB)	IL max. (dB)	IP rating
	3401.01.A	DC – 300 300 – 1000	BNC (f) – BNC (f)	MH12	26 19	0.1 0.1	IP20
	3401.01.C	DC – 1000	BNC (m) – BNC (f)	MH12	26 19	0.1 0.1	IP20
	3401.02.A	DC – 400 400 – 1000	BNC (f) – BNC (f)/75 Ω	MH12	20 15	0.1 0.2	IP20
	3401.26.A	DC – 300 300 – 1000	TNC (f) – TNC (f)	MH12	26 19	0.1 0.1	IP64
	3401.26.C	DC – 300 300 – 1000	TNC (m) – TNC (f)	MH12	26 19	0.1 0.1	IP20
	3401.26.0012-EX**	DC – 1000	TNC (f) – TNC (f)	MH12	19	0.1	IP64
	3401.17.A	DC – 1000	N (f) – N (f)	MH12	26	0.1	IP65
	3401.17.C	DC – 1000	N (m) – N (f)	MH12	26	0.1	IP65
	3401.17.K	DC – 1000	N (f) – N (f)	MH12	26	0.1	IP66
	3401.17.0048-EX **	DC – 1000	N (f) – N (f)	MH12	24	0.1	IP65
	3401.17.0057-EX **	DC – 1000	N (m) – N (f)	MH12	24	0.1	IP65
	3401.17.0056 ****	DC – 1000	N (m) – N (f)	MH12	26.4	0.1	IP67
	3402.17.A	DC – 2500	N (f) – N (f)	MH25	20	0.2	IP65
	3402.17.C	DC – 2500	N (m) – N (f)	MH25	20	0.2	IP65
	3402.17.K	DC – 1000 1000 – 2500	N (f) – N (f)	MH25	26 20	0.1 0.2	IP66
	3402.17.0033 ***	DC – 2500	N (f) – N (f)	MH25	20	0.2	IP65
	3402.17.0072-EX **	DC – 2500	N (f) – N (f)	MH25	20	0.2	IP65
	3402.17.0076-EX **	DC – 2500	N (m) – N (f)	MH25	20	0.2	IP65
	3402.17.3001	DC – 2000 2000 – 3000	N (f) – N (f)	MH25	26 20	0.2 0.3	IP67
	3402.17.3002	DC – 2000 2000 – 3000	N (m) – N (f)	MH25	26 20	0.2 0.3	IP67
	3402.18.A	DC – 1500 1500 – 2000	N (f) – N (f)/ 75 Ω	MH25	16.5 15.5	0.2 0.2	IP65
	3402.26.0002	DC – 2500	TNC (f) – TNC (f)	MH25	20	0.2	IP65
	3402.26.0004	DC – 2500	TNC (m) – TNC (f)	MH25	20	0.2	IP65
	3402.26.0006-EX *	DC – 2500	TNC (f) – TNC (f)	MH25	20	0.2	IP65
	3402.26.3001	DC – 1000 1000 – 3000	TNC (f) – TNC (f)	MH170	26 20	0.2 0.3	IP65
	3402.27.0001	DC – 1500 1500 – 2000	TNC (f) – TNC (f)/75 Ω	MH25	16.5 15.5	0.2 0.2	IP65
	3406.17.0009	DC – 5600 5600 – 5800 5800 – 6000	N (f) – N (f)	MH24	20 18.5 15	0.2	IP65
	3406.17.0012	DC – 5600 5600 – 5800 5800 – 6000	N (m) – N (f)	MH24	20 18.5 15	0.2	IP65
	3406.26.0010	DC – 2000	TNC (m) – TNC (f)	MH4	20	0.2	IP65
	3406.00.0030	DC – 3000	N (f) – SMA (f)	5/8-4UNEF	20	0.2	IP65

- * Semper GDT 9071.99.0648 (90 V) integrated
- ** Semper GDT 9071.99.0647 (230 V) integrated
- *** GDT 9071.99.0547 (230 V) integrated
- **** GDT 9071.99.0550 (470 V) integrated

Quarter wave shorting stub and LC-filter protectors

$\lambda/4$ shorting stub technology can handle extremely high surge currents and features very low residual energy. No DC voltage is allowed on the center pin. Bandwidths with a ratio of 4:1 can be realized. Depending on the selected interface they can be used in applications up to 5 kW CW.

Picture	HUBER+SUHNER type	Freq. range (MHz)	Connectors	Mounting	RL min. (dB)	IL max. (dB)	IP rating
	3407.17.0022	74 – 180	N (f) – N (f)	MH74	20	0.15	IP66
	3407.17.0088	74 – 420	N (m) – N (f)	MH74	23	0.15	IP67
	3407.17.0089	74 – 420	N (f) – N (f)	MH74	23	0.15	IP67
	3407.17.0023	220 – 450	N (m) – N (f)	MH74	20	0.1	IP65
	3407.17.0053	320 – 512	N (m) – N (f)	MH12	20	0.2	IP65
	3400.17.0388	380 – 512	N (m) – N (f)	MH74	20	0.1	IP65
	3400.17.0254	1000 – 1100	N (f) – N (f)	MH12	20	0.1	IP65
	3400.17.0385	950 – 1450	N (f) – N (f)	MH25	20	0.1	IP65
	3400.17.0247	2400 – 3600	N (m) – N (f)	MH50	20	0.15	IP67
	3400.17.0410	2000 – 6000	N (f) – N (f)	screw M8	20	0.2	IP65
	3400.17.0235	5000 – 7000	N (f) – N (f)	MH25	20	0.25	IP65
	3400.17.0380	6000 – 18 000	N (f) – N (f)	MH69	20	0.3	IP65

Hybrid GDT fine protectors

For sensitive DC powered electronics such as GPS receivers the Hybrid GDT fine protector with integrated suppressor diodes guarantees lowest residual pulse energy.

Picture	HUBER+SUHNER type	Freq. range (MHz)	Connectors	Mounting	RL min. (dB)	IL max. (dB)	IP rating
	3403.17.0050	650 – 2500	N (f) – N (f) /15 V	MH119	20.8	0.5	IP65
	3403.17.0051*	806 – 2500	N (m) – N (f) /15 V	M6/2 × Ø 4.2	20.8	0.5	IP65
	3403.17.0075	800 – 2500	N (f) – N (f) /6 V	MH12	26.4	0.3	IP67

* HEMP optimized

High power limiter

Limiters are multi-stage hybrid components which reduce harmful RF power at its input to a defined power level at the output. The special feature of the presented high power limiter is that it is not only limiting but at the same time it is capable of protecting against lightning- and NEMP pulses.

Picture	HUBER+SUHNER type	Freq. range (MHz)	Connectors	Mounting	RL min. (dB)	IL max. (dB)	IP rating
	9078.17.0013	0.1 – 32 MHz	N (f) – N (f)	MH12	18	0.5	IP67
	9078.17.0014	0.1 – 32 MHz	N (f) – N (f)	MH12	20	0.7	IP67
	9078.17.0015	0.1 – 50 MHz	N (f) – N (f)	MH12	20	0.7	IP67

HUBER+SUHNER type	RF average power	RF peak power	Limiting threshold	Surge current handling capability	Residual pulse energy (LEMP) 2 kA; 8/20 µs/4 kV; 1.2/50 µs	Residual pulse energy (NEMP) 6 kV; 5/200 ns	Response time
9078.17.0013	≤ 25 W ≤ 44 dBm	≤ 5 kW ≤ 67 dBm	10 – 12.6 W 40 – 41 dBm	10 kA (8/20 µs)	300 µJ	30 µJ	< 100 ns
9078.17.0014	≤ 25 W ≤ 44 dBm	≤ 1 kW ≤ 60 dBm	4 mW 6 dBm	10 kA (8/20 µs)	200 µJ	–	< 2 ns
9078.17.0015	≤ 25 W ≤ 44 dBm	≤ 1 kW ≤ 60 dBm	16 mW 12 dBm	10 kA (8/20 µs)	200 µJ	–	< 2 ns

Gas discharge tube (GDT) protectors

This technology features bandwidths from DC – 6 GHz and can handle surge currents up to 30kA. GDT technology allows DC voltage on the center conductor. By selecting the correct GDT these products can be used in applications with transmit power up to 1 kW CW. For applications with higher power please consult the factory. A special version of this technology is represented by the self-extinguishing GDT protector (Semper). GDT technology provides reliable protection against natural and man-made surges.

Picture	HUBER+SUHNER type	Freq. range (MHz)	Connectors	Mounting	RL min. (dB)	IL max. (dB)	IP rating
	3401.01.A	DC – 300 300 – 1000	BNC (f) – BNC (f)	MH12	26 19	0.1 0.1	IP20
	3401.01C	DC – 1000	BNC (m) – BNC (f)	MH12	26 19	0.1 0.1	IP20
	3401.02.A	DC – 400 400 – 1000	BNC (f) – BNC (f)/75 Ω	MH12	20 15	0.1 0.2	IP20
	3401.26.A	DC – 300 300 – 1000	TNC (f) – TNC (f)	MH12	26 19	0.1 0.1	IP64
	3401.26.C	DC – 300 300 – 1000	TNC (m) – TNC (f)	MH12	26 19	0.1 0.1	IP20
	3401.26.0012-EX**	DC – 1000	TNC (f) – TNC (f)	MH12	19	0.1	IP64
	3401.17.A	DC – 1000	N (f) – N (f)	MH12	26	0.1	IP65
	3401.17.C	DC – 1000	N (m) – N (f)	MH12	26	0.1	IP65
	3401.17.K	DC – 1000	N (f) – N (f)	MH12	26	0.1	IP66
	3401.17.0048-EX **	DC – 1000	N (f) – N (f)	MH12	24	0.1	IP65
	3401.17.0057-EX **	DC – 1000	N (m) – N (f)	MH12	24	0.1	IP65
	3401.17.0056 ****	DC – 1000	N (m) – N (f)	MH12	26.4	0.1	IP67
	3402.17.A	DC – 2500	N (f) – N (f)	MH25	20	0.2	IP65
	3402.17.C	DC – 2500	N (m) – N (f)	MH25	20	0.2	IP65
	3402.17.K	DC – 1000 1000 – 2500	N (f) – N (f)	MH25	26 20	0.1 0.2	IP66
	3402.17.0033 ***	DC – 2500	N (f) – N (f)	MH25	20	0.2	IP65
	3402.17.0072-EX **	DC – 2500	N (f) – N (f)	MH25	20	0.2	IP65
	3402.17.0076-EX **	DC – 2500	N (m) – N (f)	MH25	20	0.2	IP65
	3402.17.3001	DC – 2000 2000 – 3000	N (f) – N (f)	MH25	26 20	0.2 0.3	IP67
	3402.17.3002	DC – 2000 2000 – 3000	N (m) – N (f)	MH25	26 20	0.2 0.3	IP67
	3402.18.A	DC – 1500 1500 – 2000	N (f) – N (f)/ 75 Ω	MH25	16.5 15.5	0.2 0.2	IP65
	3402.26.0002	DC – 2500	TNC (f) – TNC (f)	MH25	20	0.2	IP65
	3402.26.0004	DC – 2500	TNC (m) – TNC (f)	MH25	20	0.2	IP65
	3402.26.0006-EX *	DC – 2500	TNC (f) – TNC (f)	MH25	20	0.2	IP65
	3402.26.3001	DC – 1000 1000 – 3000	TNC (f) – TNC (f)	MH170	26 20	0.2 0.3	IP65
	3402.27.0001	DC – 1500 1500 – 2000	TNC (f) – TNC (f)/75 Ω	MH25	16.5 15.5	0.2 0.2	IP65
	3406.17.0009	DC – 5600 5600 – 5800 5800 – 6000	N (f) – N (f)	MH24	20 18.5 15	0.2	IP65
	3406.17.0012	DC – 5600 5600 – 5800 5800 – 6000	N (m) – N (f)	MH24	20 18.5 15	0.2	IP65
	3406.26.0010	DC – 2000	TNC (m) – TNC (f)	MH4	20	0.2	IP65
	3406.00.0030	DC – 3000	N (f) – SMA (f)	5/8-4UNEF	20	0.2	IP65

- * Semper GDT 9071.99.0648 (90 V) integrated
- ** Semper GDT 9071.99.0647 (230 V) integrated
- *** GDT 9071.99.0547 (230 V) integrated
- **** GDT 9071.99.0550 (470 V) integrated

Quarter wave shorting stub and LC-filter protectors

$\lambda/4$ shorting stub technology can handle extremely high surge currents and features very low residual energy. No DC voltage is allowed on the center pin. Bandwidths with a ratio of 4:1 can be realized. Depending on the selected interface they can be used in applications up to 5 kW CW.

Picture	HUBER+SUHNER type	Freq. range (MHz)	Connectors	Mounting	RL min. (dB)	IL max. (dB)	IP rating
	3407.17.0022	74 – 180	N (f) – N (f)	MH74	20	0.15	IP66
	3407.17.0088	74 – 420	N (m) – N (f)	MH74	23	0.15	IP67
	3407.17.0089	74 – 420	N (f) – N (f)	MH74	23	0.15	IP67
	3407.17.0023	220 – 450	N (m) – N (f)	MH74	20	0.1	IP65
	3407.17.0053	320 – 512	N (m) – N (f)	MH12	20	0.2	IP65
	3400.17.0388	380 – 512	N (m) – N (f)	MH74	20	0.1	IP65
	3400.17.0254	1000 – 1100	N (f) – N (f)	MH12	20	0.1	IP65
	3400.17.0385	950 – 1450	N (f) – N (f)	MH25	20	0.1	IP65
	3400.17.0247	2400 – 3600	N (m) – N (f)	MH50	20	0.15	IP67
	3400.17.0410	2000 – 6000	N (f) – N (f)	screw M8	20	0.2	IP65
	3400.17.0235	5000 – 7000	N (f) – N (f)	MH25	20	0.25	IP65
	3400.17.0380	6000 – 18 000	N (f) – N (f)	MH69	20	0.3	IP65

Hybrid GDT fine protectors

For sensitive DC powered electronics such as GPS receivers the Hybrid GDT fine protector with integrated suppressor diodes guarantees lowest residual pulse energy.

Picture	HUBER+SUHNER type	Freq. range (MHz)	Connectors	Mounting	RL min. (dB)	IL max. (dB)	IP rating
	3403.17.0050	650 – 2500	N (f) – N (f) /15 V	MH119	20.8	0.5	IP65
	3403.17.0051*	806 – 2500	N (m) – N (f) /15 V	M6/2 × Ø 4.2	20.8	0.5	IP65
	3403.17.0075	800 – 2500	N (f) – N (f) /6 V	MH12	26.4	0.3	IP67

* HEMP optimized

High power limiter

Limiters are multi-stage hybrid components which reduce harmful RF power at its input to a defined power level at the output. The special feature of the presented high power limiter is that it is not only limiting but at the same time it is capable of protecting against lightning- and NEMP pulses.

Picture	HUBER+SUHNER type	Freq. range (MHz)	Connectors	Mounting	RL min. (dB)	IL max. (dB)	IP rating
	9078.17.0013	0.1 – 32 MHz	N (f) – N (f)	MH12	18	0.5	IP67
	9078.17.0014	0.1 – 32 MHz	N (f) – N (f)	MH12	20	0.7	IP67
	9078.17.0015	0.1 – 50 MHz	N (f) – N (f)	MH12	20	0.7	IP67

HUBER+SUHNER type	RF average power	RF peak power	Limiting threshold	Surge current handling capability	Residual pulse energy (LEMP) 2 kA; 8/20 µs/4 kV; 1.2/50 µs	Residual pulse energy (NEMP) 6 kV; 5/200 ns	Response time
9078.17.0013	≤ 25 W ≤ 44 dBm	≤ 5 kW ≤ 67 dBm	10 – 12.6 W 40 – 41 dBm	10 kA (8/20 µs)	300 µJ	30 µJ	< 100 ns
9078.17.0014	≤ 25 W ≤ 44 dBm	≤ 1 kW ≤ 60 dBm	4 mW 6 dBm	10 kA (8/20 µs)	200 µJ	–	< 2 ns
9078.17.0015	≤ 25 W ≤ 44 dBm	≤ 1 kW ≤ 60 dBm	16 mW 12 dBm	10 kA (8/20 µs)	200 µJ	–	< 2 ns

HUBER+SUHNER AG
Degersheimerstrasse 14
9100 Herisau
Switzerland
Phone: +41 71 353 4111
hubersuhner.com

HUBER+SUHNER Astrolab
4 Powder Horn Drive
Warren, New Jersey
07059-5105 USA
Phone: 732-560-3800
Fax: 732-560-9570
hubersuhner.com

HUBER+SUHNER is certified according to EN(AS) 9100, ISO 9001, ISO 14001, ISO/TS 16949 and IRIS.

Waiver

Fact and figures herein are for information only and do not represent any warranty of any kind.